



Intel® Desktop Board D845GVSR Technical Product Specification

July 2003

Order Number: C46811-001

The Intel® Desktop Board D845GVSR may contain design defects or errors known as errata that may cause the product to deviate from published specifications. Current characterized errata are documented in the Intel Desktop Board D845GVSR Specification Update.

Revision History

| Revision | Revision History | Date |
|----------|---|-----------|
| -001 | First release of the Intel® Desktop Board D845GVSR Technical Product Specification. | July 2003 |

This product specification applies to only standard Intel® Desktop Board D845GVSR with BIOS identifier VA84510A.86A.

Changes to this specification will be published in the Intel Desktop Board D845GVSR Specification Update before being incorporated into a revision of this document.

INFORMATION IN THIS DOCUMENT IS PROVIDED IN CONNECTION WITH INTEL® PRODUCTS. EXCEPT AS PROVIDED IN INTEL'S TERMS AND CONDITIONS OF SALE FOR SUCH PRODUCTS, INTEL ASSUMES NO LIABILITY WHATSOEVER, AND INTEL DISCLAIMS ANY EXPRESS OR IMPLIED WARRANTY, RELATING TO SALE AND/OR USE OF INTEL PRODUCTS INCLUDING LIABILITY OR WARRANTIES RELATING TO FITNESS FOR A PARTICULAR PURPOSE, MERCHANTABILITY, OR INFRINGEMENT OF ANY PATENT, COPYRIGHT, OR OTHER INTELLECTUAL PROPERTY RIGHT.

Intel Corporation may have patents or pending patent applications, trademarks, copyrights, or other intellectual property rights that relate to the presented subject matter. The furnishing of documents and other materials and information does not provide any license, express or implied, by estoppel or otherwise, to any such patents, trademarks, copyrights, or other intellectual property rights.

Intel products are not intended for use in medical, life saving, or life sustaining applications or for any other application in which the failure of the Intel product could create a situation where personal injury or death may occur.

Intel may make changes to specifications, product descriptions, and plans at any time, without notice.

The Intel® Desktop Board D845GVSR may contain design defects or errors known as errata that may cause the product to deviate from published specifications. Current characterized errata are available on request.

Contact your local Intel sales office or your distributor to obtain the latest specifications before placing your product order.

Copies of documents which have an ordering number and are referenced in this document, or other Intel literature, may be obtained from:

Intel Corporation
P.O. Box 5937
Denver, CO 80217-9808

or call in North America 1-800-548-4725, Europe 44-0-1793-431-155, France 44-0-1793-421-777,
Germany 44-0-1793-421-333, other countries 708-296-9333.

Intel, Pentium, and Celeron are registered trademarks of Intel Corporation or its subsidiaries in the United States and other countries.

† Other names and brands may be claimed as the property of others.

Copyright © 2003, Intel Corporation. All rights reserved.

Preface

This Technical Product Specification (TPS) specifies the board layout, components, connectors, power and environmental requirements, and the BIOS for the Intel® Desktop Board D845GVSR. It describes the standard product and available manufacturing options.

Intended Audience

The TPS is intended to provide detailed, technical information about the Desktop Board D845GVSR and their components to the vendors, system integrators, and other engineers and technicians who need this level of information. It is specifically *not* intended for general audiences.

What This Document Contains

| Chapter | Description |
|---------|--|
| 1 | A description of the hardware used on the Desktop Board D845GVSR |
| 2 | A map of the resources of the Desktop Board |
| 3 | The features supported by the BIOS Setup program |
| 4 | The contents of the BIOS Setup program's menus and submenus |
| 5 | A description of the BIOS error messages, beep codes, and POST codes |

Typographical Conventions

This section contains information about the conventions used in this specification. Not all of these symbols and abbreviations appear in all specifications of this type.

Notes, Cautions, and Warnings

NOTE

Notes call attention to important information.

INTEGRATOR'S NOTES

Integrator's notes are used to call attention to information that may be useful to system integrators.

CAUTION

Cautions are included to help you avoid damaging hardware or losing data.



WARNING

Warnings indicate conditions, which if not observed, can cause personal injury.

Other Common Notation

| | |
|-----------|---|
| # | Used after a signal name to identify an active-low signal (such as USBP0#) |
| (NxnX) | When used in the description of a component, N indicates component type, xn are the relative coordinates of its location on the Desktop Board D845GVSR, and X is the instance of the particular part at that general location. For example, J5J1 is a connector, located at 5J. It is the first connector in the 5J area. |
| GB | Gigabyte (1,073,741,824 bytes) |
| GB/sec | Gigabytes per second |
| KB | Kilobyte (1024 bytes) |
| Kbit | Kilobit (1024 bits) |
| kbits/sec | 1000 bits per second |
| MB | Megabyte (1,048,576 bytes) |
| MB/sec | Megabytes per second |
| Mbit | Megabit (1,048,576 bits) |
| Mbit/sec | Megabits per second |
| xxh | An address or data value ending with a lowercase h indicates a hexadecimal value. |
| x.x V | Volts. Voltages are DC unless otherwise specified. |
| † | This symbol is used to indicate third-party brands and names that are the property of their respective owners. |

Contents

1 Product Description

| | | |
|--------|--|----|
| 1.1 | Overview | 12 |
| 1.1.1 | Feature Summary | 12 |
| 1.1.2 | Manufacturing Options | 13 |
| 1.1.3 | Board Layout..... | 14 |
| 1.2 | Block Diagram | 15 |
| 1.3 | Online Support | 16 |
| 1.4 | Operating System Support | 16 |
| 1.5 | Design Specifications | 17 |
| 1.6 | Processor | 20 |
| 1.7 | System Memory | 21 |
| 1.8 | Intel® 845GV Chipset..... | 23 |
| 1.8.1 | Intel® Extreme Graphics Controller..... | 23 |
| 1.8.2 | USB..... | 28 |
| 1.8.3 | IDE Interfaces | 28 |
| 1.8.4 | Real-Time Clock, CMOS SRAM, and Battery..... | 29 |
| 1.9 | I/O Controller | 30 |
| 1.9.1 | Serial Ports | 30 |
| 1.9.2 | Parallel Port..... | 30 |
| 1.9.3 | Diskette Drive Controller | 30 |
| 1.9.4 | Keyboard and Mouse Interface | 30 |
| 1.10 | Audio Subsystem..... | 31 |
| 1.10.1 | Audio Connectors..... | 31 |
| 1.10.2 | Audio Subsystem Software | 32 |
| 1.11 | LAN Subsystem (Optional) | 32 |
| 1.11.1 | Intel® 82562ET Platform LAN Connect Device | 32 |
| 1.11.2 | RJ-45 LAN Connector with Integrated LEDs | 33 |
| 1.11.3 | LAN Subsystem Software | 33 |
| 1.12 | Hardware Management Subsystem (Optional) | 33 |
| 1.12.1 | Hardware Monitoring and Fan Control ASIC | 33 |
| 1.12.2 | Fan Monitoring | 34 |
| 1.12.3 | Chassis Intrusion and Detection..... | 34 |
| 1.13 | Power Management | 34 |
| 1.13.1 | ACPI..... | 34 |
| 1.13.2 | Hardware Support..... | 37 |

2 Technical Reference

| | | |
|-----|-----------------------------------|----|
| 2.1 | Introduction..... | 41 |
| 2.2 | Memory Map | 41 |
| 2.3 | Fixed I/O Map..... | 42 |
| 2.4 | DMA Channels | 43 |
| 2.5 | PCI Configuration Space Map | 43 |
| 2.6 | Interrupts | 44 |

| | | |
|--------|--|----|
| 2.7 | PCI Interrupt Routing Map | 45 |
| 2.8 | Connectors | 47 |
| 2.8.1 | Back Panel Connectors | 48 |
| 2.8.2 | Internal I/O Connectors | 49 |
| 2.8.3 | External I/O Connectors | 54 |
| 2.9 | Jumper Blocks | 58 |
| 2.9.1 | Front Panel Audio Connector/Jumper Block..... | 58 |
| 2.9.2 | BIOS Setup Configuration Jumper Block..... | 59 |
| 2.10 | Mechanical Considerations..... | 60 |
| 2.10.1 | I/O Shield | 61 |
| 2.11 | Electrical Considerations | 62 |
| 2.11.1 | DC Loading | 62 |
| 2.11.2 | Add-in Board Considerations..... | 62 |
| 2.11.3 | Fan Connector Current Capability | 62 |
| 2.11.4 | Power Supply Considerations | 63 |
| 2.12 | Thermal Considerations..... | 63 |
| 2.13 | Reliability | 65 |
| 2.14 | Environmental | 65 |
| 2.15 | Regulatory Compliance | 66 |
| 2.15.1 | Safety Regulations | 66 |
| 2.15.2 | EMC Regulations | 66 |
| 2.15.3 | European Union Declaration of Conformity Statement | 67 |
| 2.15.4 | Product Ecology Statements | 67 |
| 2.15.5 | Product Certification Markings (Board Level) | 68 |

3 Overview of BIOS Features

| | | |
|-------|---|----|
| 3.1 | Introduction..... | 69 |
| 3.2 | BIOS Flash Memory Organization | 70 |
| 3.3 | Resource Configuration | 70 |
| 3.3.1 | PCI Autoconfiguration | 70 |
| 3.3.2 | PCI IDE Support..... | 70 |
| 3.4 | System Management BIOS (SMBIOS)..... | 71 |
| 3.5 | Legacy USB Support | 71 |
| 3.6 | BIOS Updates | 72 |
| 3.6.1 | Language Support..... | 72 |
| 3.6.2 | Custom Splash Screen..... | 73 |
| 3.7 | Recovering BIOS Data | 73 |
| 3.8 | Boot Options..... | 74 |
| 3.8.1 | CD-ROM Boot..... | 74 |
| 3.8.2 | Network Boot..... | 74 |
| 3.8.3 | Booting Without Attached Devices | 74 |
| 3.8.4 | Changing the Default Boot Device During POST..... | 74 |
| 3.9 | Fast Booting Systems with Intel® Rapid BIOS Boot..... | 75 |
| 3.9.1 | Peripheral Selection and Configuration | 75 |
| 3.9.2 | Intel Rapid BIOS Boot | 75 |
| 3.10 | BIOS Security Features..... | 76 |

4 BIOS Setup Program

| | | |
|-------|---------------------------------------|-----|
| 4.1 | Introduction..... | 77 |
| 4.2 | Maintenance Menu..... | 78 |
| 4.3 | Main Menu..... | 79 |
| 4.4 | Advanced Menu..... | 80 |
| 4.4.1 | PCI Configuration Submenu..... | 81 |
| 4.4.2 | Boot Configuration Submenu..... | 82 |
| 4.4.3 | Peripheral Configuration Submenu..... | 83 |
| 4.4.4 | IDE Configuration Submenu..... | 85 |
| 4.4.5 | Diskette Configuration Submenu..... | 88 |
| 4.4.6 | Event Log Configuration Submenu..... | 89 |
| 4.4.7 | Video Configuration Submenu..... | 90 |
| 4.4.8 | USB Configuration Submenu..... | 91 |
| 4.4.9 | Chipset Configuration Submenu..... | 92 |
| 4.5 | Security Menu..... | 94 |
| 4.6 | Power Menu..... | 95 |
| 4.6.1 | ACPI Submenu..... | 95 |
| 4.7 | Boot Menu..... | 96 |
| 4.7.1 | Boot Device Priority Submenu..... | 97 |
| 4.7.2 | Hard Disk Drives Submenu..... | 98 |
| 4.7.3 | Removable Devices Submenu..... | 98 |
| 4.7.4 | ATAPI CD-ROM Drives Submenu..... | 99 |
| 4.8 | Exit Menu..... | 100 |

5 Error Messages and Beep Codes

| | | |
|-----|-------------------------------------|-----|
| 5.1 | BIOS Error Messages..... | 101 |
| 5.2 | Port 80h POST Codes..... | 103 |
| 5.3 | Bus Initialization Checkpoints..... | 107 |
| 5.4 | Speaker..... | 108 |
| 5.5 | BIOS Beep Codes..... | 108 |

Figures

| | | |
|-----|--|----|
| 1. | Desktop Board D845GVSR Components..... | 14 |
| 2. | Block Diagram..... | 15 |
| 3. | Location of the Standby Power Indicator LED on the D845GVSR Board..... | 40 |
| 4. | Back Panel Connectors..... | 48 |
| 5. | Audio, Power, and Hardware Control Connectors..... | 50 |
| 6. | Add-in Board and Peripheral Interface Connectors..... | 53 |
| 7. | External I/O Connectors..... | 54 |
| 8. | Connection Diagram for Front Panel Connector..... | 55 |
| 9. | Connection Diagram for Front Panel USB Connector..... | 57 |
| 10. | Location of the Jumper Blocks..... | 58 |
| 11. | Desktop Board Dimensions..... | 60 |
| 12. | I/O Shield Dimensions..... | 61 |
| 13. | Localized High Temperature Zones..... | 64 |

Tables

| | | |
|-----|--|----|
| 1. | Feature Summary..... | 12 |
| 2. | Manufacturing Options | 13 |
| 3. | Specifications | 17 |
| 4. | Supported System Bus Frequency and Memory Speed Combinations..... | 21 |
| 5. | Supported DDR DIMM Configurations..... | 22 |
| 6. | Direct Draw Supported Modes..... | 24 |
| 7. | Video BIOS Video Modes Supported for Analog CRTs..... | 25 |
| 8. | Supported Configuration Modes | 26 |
| 9. | Details of bpp Configuration Modes..... | 27 |
| 10. | LAN Connector LED States | 33 |
| 11. | Effects of Pressing the Power Switch | 35 |
| 12. | Power States and Targeted System Power | 36 |
| 13. | Wake-up Devices and Events..... | 36 |
| 14. | Fan Connector Function/Operation..... | 38 |
| 15. | System Memory Map..... | 41 |
| 16. | I/O Map | 42 |
| 17. | DMA Channels | 43 |
| 18. | PCI Configuration Space Map | 43 |
| 19. | Interrupts | 44 |
| 20. | PCI Interrupt Routing Map..... | 46 |
| 21. | Front Panel Audio Connector | 51 |
| 22. | Auxiliary Line In Connector..... | 51 |
| 23. | ATAPI CD-ROM Connector..... | 51 |
| 24. | ATX12V Power Connector..... | 51 |
| 25. | Rear Chassis Fan Connector | 52 |
| 26. | Processor Fan Connector..... | 52 |
| 27. | Main Power Connector | 52 |
| 28. | Front Chassis Fan Connector..... | 52 |
| 29. | Chassis Intrusion Connector..... | 52 |
| 30. | Serial Port B Connector (optional) | 54 |
| 31. | Auxiliary Front Panel Power/Sleep/Message-Waiting LED Connector..... | 55 |
| 32. | Front Panel Connector | 55 |
| 33. | States for a One-Color Power LED..... | 56 |
| 34. | States for a Two-Color Power LED..... | 56 |
| 35. | Front Panel Audio Connector/Jumper Block..... | 59 |
| 36. | BIOS Setup Configuration Jumper Settings..... | 59 |
| 37. | DC Loading Characteristics | 62 |
| 38. | Fan Connector Current Capability | 62 |
| 39. | Thermal Considerations for Components | 64 |
| 40. | Desktop Board D845GVSR Environmental Specifications..... | 65 |
| 41. | Safety Regulations | 66 |
| 42. | EMC Regulations..... | 66 |
| 43. | Product Certification Markings..... | 68 |
| 44. | Boot Device Menu Options | 74 |
| 45. | Supervisor and User Password Functions | 76 |
| 46. | BIOS Setup Program Menu Bar | 77 |

| | | |
|-----|--|-----|
| 47. | BIOS Setup Program Function Keys | 78 |
| 48. | Maintenance Menu | 78 |
| 49. | Main Menu..... | 79 |
| 50. | Advanced Menu..... | 80 |
| 51. | PCI Configuration Submenu | 81 |
| 52. | Boot Configuration Submenu..... | 82 |
| 53. | Peripheral Configuration Submenu..... | 83 |
| 54. | IDE Configuration Submenu | 85 |
| 55. | Primary/Secondary IDE Master/Slave Submenus..... | 86 |
| 56. | Diskette Configuration Submenu | 88 |
| 57. | Event Log Configuration Submenu | 89 |
| 58. | Video Configuration Submenu | 90 |
| 59. | USB Configuration Submenu..... | 91 |
| 60. | Chipset Configuration Submenu | 92 |
| 61. | Security Menu | 94 |
| 62. | Power Menu | 95 |
| 63. | ACPI Submenu..... | 95 |
| 64. | Boot Menu | 96 |
| 65. | Boot Device Priority Submenu | 97 |
| 66. | Hard Disk Drives Submenu | 98 |
| 67. | Removable Devices Submenu..... | 98 |
| 68. | ATAPI CD-ROM Drives Submenu | 99 |
| 69. | Exit Menu | 100 |
| 70. | BIOS Error Messages..... | 101 |
| 71. | Uncompressed INIT Code Checkpoints..... | 103 |
| 72. | Boot Block Recovery Code Checkpoints | 103 |
| 73. | Runtime Code Uncompressed in F000 Shadow RAM | 104 |
| 74. | Bus Initialization Checkpoints | 107 |
| 75. | Upper Nibble High Byte Functions..... | 107 |
| 76. | Lower Nibble High Byte Functions..... | 108 |
| 77. | Beep Codes..... | 109 |

1 Product Description

What This Chapter Contains

| | | |
|------|--|----|
| 1.1 | Overview | 12 |
| 1.2 | Block Diagram | 15 |
| 1.3 | Online Support | 16 |
| 1.4 | Operating System Support | 16 |
| 1.5 | Design Specifications | 17 |
| 1.6 | Processor | 20 |
| 1.7 | System Memory | 21 |
| 1.8 | Intel® 845GV Chipset..... | 23 |
| 1.9 | I/O Controller | 30 |
| 1.10 | Audio Subsystem..... | 31 |
| 1.11 | LAN Subsystem (Optional) | 32 |
| 1.12 | Hardware Management Subsystem (Optional) | 33 |
| 1.13 | Power Management | 34 |

1.1 Overview

1.1.1 Feature Summary

Table 1 summarizes the major features of the Intel® Desktop Board D845GVSR.

Table 1. Feature Summary

| | |
|--|---|
| Form Factor | microATX (9.20 inches by 8.20 inches [233.68 millimeters by 208.28 millimeters]) |
| Processor | <ul style="list-style-type: none"> • Support for an Intel® Pentium® 4 processor in an mPGA478 socket with a 400/533 MHz system bus • Support for an Intel® Celeron® processor in an mPGA478 socket with a 400 MHz system bus |
| Memory | <ul style="list-style-type: none"> • Two 184-pin DDR SDRAM Dual Inline Memory Module (DIMM) sockets • Support for single-sided or double-sided DIMMs (DDR333/266/200) • Support for up to 2 GB system memory |
| Chipset | Intel® 845GV Chipset, consisting of: <ul style="list-style-type: none"> • Intel® 82845GV Graphics and Memory Controller Hub (GMCH) • Intel® 82801DB I/O Controller Hub (ICH4) • 4 Mbit Firmware Hub (FWH) |
| Video | Intel® Extreme Graphics controller |
| Audio | Audio subsystem for AC '97 processing using the Realtek ALC202A codec |
| I/O Control | SMSC LPC47M172 LPC Bus I/O controller or National Semiconductor PC87372 LPC Bus I/O controller |
| USB | Support for USB 2.0 devices |
| Peripheral Interfaces | <ul style="list-style-type: none"> • Up to six USB ports • One serial port • One parallel port • Two IDE interfaces with UDMA 33, ATA-66/100 support • One diskette drive interface • PS/2[†] keyboard and mouse ports • Three fan connectors |
| Expansion Capabilities | Three PCI bus add-in card connectors (SMBus routed to PCI bus connector 2) |
| BIOS | <ul style="list-style-type: none"> • Intel/AMI BIOS (resident in the 4 Mbit FWH) • Support for Advanced Configuration and Power Interface (ACPI), Plug and Play, and SMBIOS |
| Instantly Available PC Technology | <ul style="list-style-type: none"> • Support for PCI Local Bus Specification Revision 2.2 • Suspend to RAM support • Wake on PCI, RS-232, front panel, PS/2 devices, and USB ports |

1.1.2 Manufacturing Options

Table 2 describes the manufacturing options on the Desktop Board D845GVSR. Not every manufacturing option is available in all marketing channels. Please contact your Intel representative to determine which manufacturing options are available to you.

Table 2. Manufacturing Options

| | |
|-----------------------------------|--|
| LAN | Intel® 82562ET 10/100 Mbit/sec Platform LAN Connect (PLC) device |
| Hardware Monitor Subsystem | <ul style="list-style-type: none"> • Hardware monitoring and fan control ASIC • Three fan sense inputs used to monitor fan activity • Chassis intrusion detection |
| Serial Port B | <ul style="list-style-type: none"> • Connector for a second serial port |

| For information about | Refer to |
|---|----------------------|
| The board's compliance level with ACPI, Plug and Play, and SMBIOS | Section 1.5, page 17 |
| Available configurations for the Desktop Board D845GVSR | Section 1.3, page 16 |

1.1.3 Board Layout

Figure 1 shows the location of the major components on the Desktop Board D845GVSR.

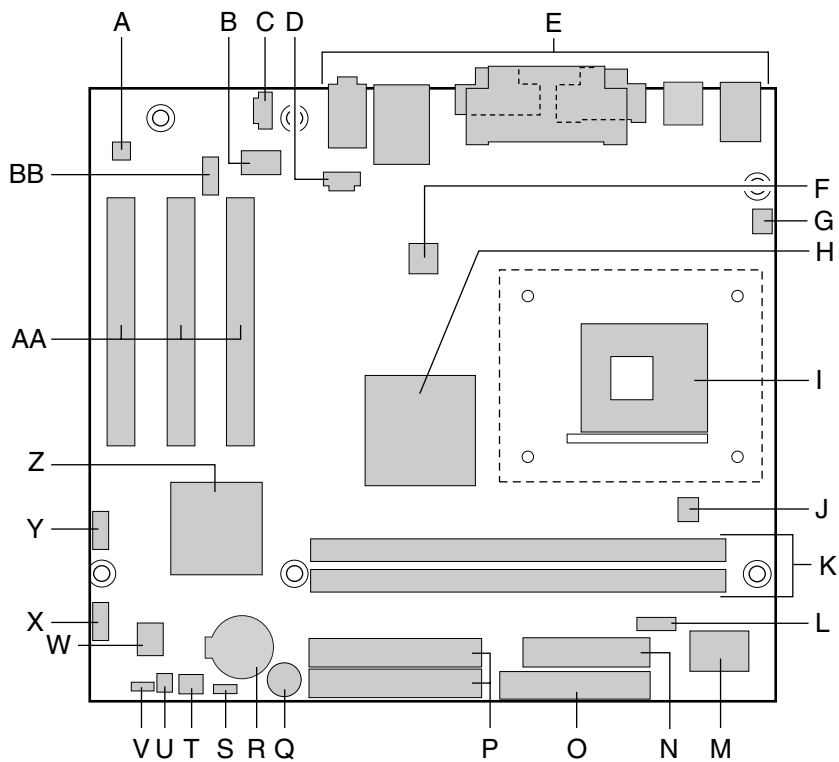

OM16233

| | | | |
|---|---|----|---|
| A | Audio codec | O | Diskette drive connector |
| B | Intel 82562ET 10/100 Mbit/sec (PLC) device (optional) | P | IDE connectors |
| C | Auxiliary line-in connector | Q | Speaker |
| D | ATAPI CD-ROM connector | R | Battery |
| E | Back panel connectors | S | Auxiliary front panel power LED connector |
| F | +12V power connector (ATX12V) | T | Front chassis fan connector |
| G | Rear chassis fan connector | U | Chassis intrusion connector |
| H | Intel 82845GV GMCH | V | BIOS Setup configuration jumper block |
| I | mPGA478 processor socket | W | 4 Mbit Firmware Hub (FWH) |
| J | Processor fan connector | X | Front panel connector |
| K | DIMM sockets | Y | Front panel USB connector |
| L | Serial Port B connector (optional) | Z | Intel 82801DB I/O Controller Hub (ICH4) |
| M | I/O Controller | AA | PCI bus add-in card connectors |
| N | Power connector | BB | Front panel audio connector |

Figure 1. Desktop Board D845GVSR Components

1.2 Block Diagram

Figure 2 is a block diagram of the major functional areas of the board.

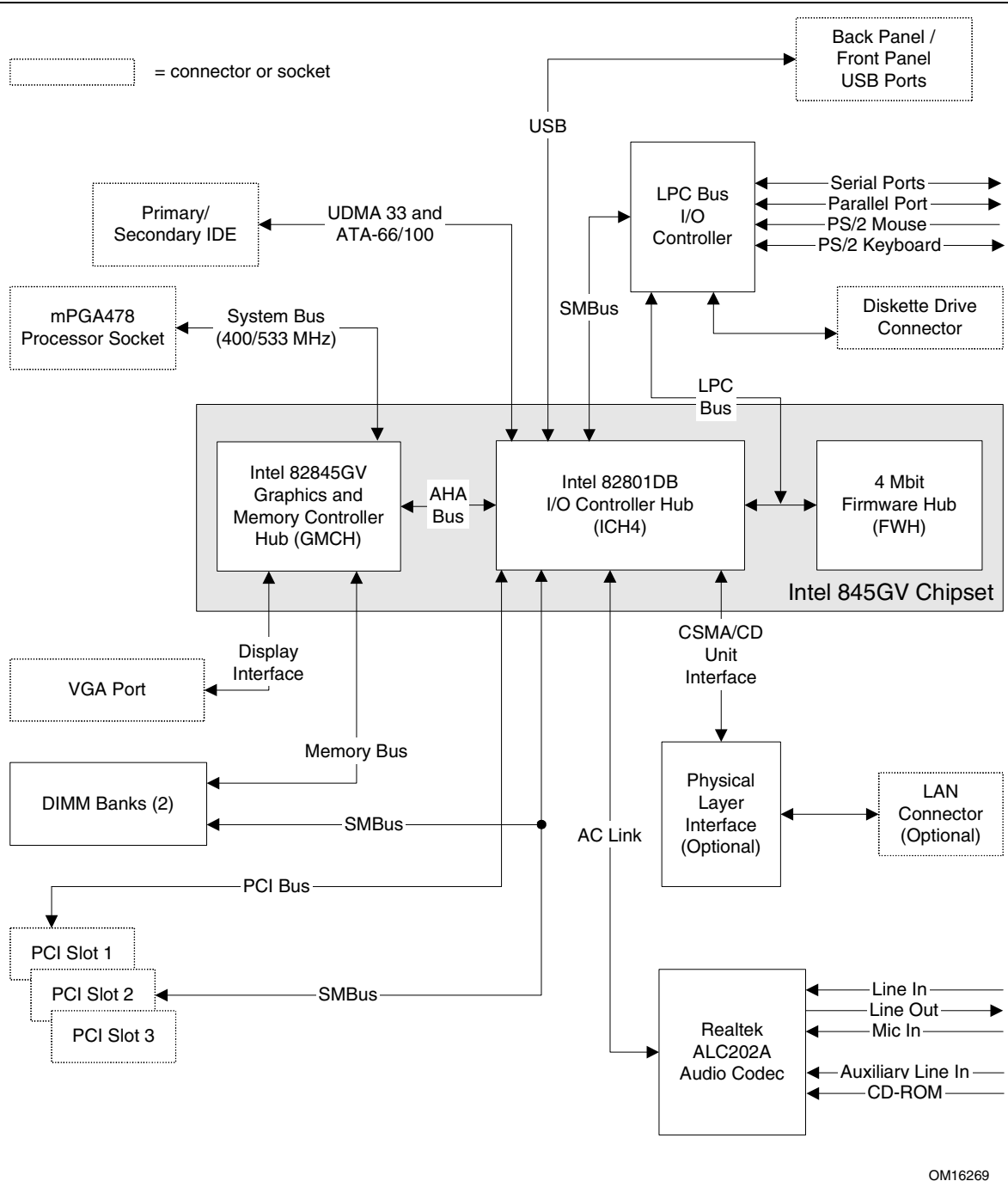

OM16269

Figure 2. Block Diagram

1.3 Online Support

| To find information about... | Visit this World Wide Web site: |
|--|--|
| Intel Desktop Board D845GVSR under “Desktop Board Products” or “Desktop Board Support” | http://www.intel.com/design/motherbd http://support.intel.com/support/motherboards/desktop |
| Available configurations for the Desktop Board D845GVSR | http://developer.intel.com/design/motherbd/sr/sr_available.htm |
| Processor data sheets | http://www.intel.com/design/litcentr |
| ICH4 addressing | http://developer.intel.com/design/chipsets/datashts |
| Custom splash screens | http://intel.com/design/motherbd/gen_indx.htm |
| Audio software and utilities | http://www.intel.com/design/motherbd |
| LAN software and drivers | http://www.intel.com/design/motherbd |

1.4 Operating System Support

The Desktop Board D845GVSR supports drivers for all of the onboard hardware and subsystems under the following operating systems:

- Windows[†] XP
- Windows ME
- Windows 2000
- Microsoft Windows 98 SE

| For information about | Refer to |
|-----------------------|-------------|
| Supported drivers | Section 1.3 |

NOTE

Third party vendors may offer other drivers.

1.5 Design Specifications

Table 3 lists the specifications applicable to the Desktop Board D845GVSR.

Table 3. Specifications

| Reference Name | Specification Title | Version, Revision Date, and Ownership | The information is available from... |
|----------------|---|---|---|
| AC '97 | <i>Audio Codec '97</i> | Revision 2.2, September 2000, Intel Corporation. | http://download.intel.com/labs/media/audio/download/ac97r22.pdf |
| ACPI | <i>Advanced Configuration and Power Interface Specification</i> | Version 1.0b, February 08, 1999, Intel Corporation, Microsoft Corporation, and Toshiba Corporation. | http://www.acpi.info/spec10b.htm |
| ASF | <i>Alert Standard Format (ASF) Specification</i> | Version 1.03, June 20, 2001, DMTF, Intel Corporation. | http://www.dmtf.org/standards/documents/ASF/DSP0114.pdf |
| ATA/ATAPI-5 | <i>Information Technology-AT Attachment with Packet Interface - 5 (ATA/ATAPI-5)</i> | Revision 3, February 29, 2000, Contact: T13 Chair, Seagate Technology. | http://www.t13.org |
| ATX | <i>ATX Specification</i> | Version 2.03, December 1998, Intel Corporation. | http://www.formfactors.org/developer/specs/atx/atxspe.htm |
| ATX12V | <i>ATX/ATX12V Power Supply Design Guide</i> | Version 1.2, August 2000, Intel Corporation. | http://www.formfactors.org/developer/specs/atx/atxspe.htm |
| BIS | <i>Boot Integrity Services (BIS) Application Programming Interface (API)</i> | Version 1.0, August 4, 1999, Intel Corporation. | http://www.intel.com/labs/manage/wfm/wfmspecs.htm |
| DDR SDRAM | <i>Double Data Rate (DDR) SDRAM Specification</i> | Version 1.0, June 2000, JEDEC Solid State Technology Association. | http://www.jedec.org/ |
| | <i>Design Specification for a 184 Pin DDR Unbuffered DIMM</i> | Revision 1.0, October 2001, JEDEC Solid State Technology Association. | http://www.jedec.org/ |
| | <i>Intel® JEDEC DDR 200/266 Unbuffered DIMM Specification Addendum</i> | Revision 0.9, September 27, 2001, Intel Corporation. | http://developer.intel.com/technology/memory/index.htm |

continued

Table 3. Specifications (continued)

| Reference Name | Specification Title | Version, Revision Date and Ownership | The information is available from... |
|-----------------------|--|--|---|
| EHCI | <i>Enhanced Host Controller Interface Specification for Universal Serial Bus</i> | Revision 1.0, March 12, 2002, Intel Corporation. | http://developer.intel.com/technology/usb/download/ehci-r10.pdf |
| EPP | <i>IEEE Std 1284.1-1997 (Enhanced Parallel Port)</i> | Version 1.7, 1997, Institute of Electrical and Electronic Engineers. | http://standards.ieee.org/reading/ieee/std_public/description/busarch/1284.1-1997_desc.html |
| EI Torito | <i>Bootable CD-ROM Format Specification</i> | Version 1.0, January 25, 1995, Phoenix Technologies Limited and International Business Machines Corporation. | http://www.phoenix.com/resources/specs-cdrom.pdf |
| LPC | <i>Low Pin Count Interface Specification</i> | Revision 1.0, September 29, 1997, Intel Corporation. | http://www.intel.com/design/chipsets/industry/lpc.htm |
| MicroATX | <i>microATX Motherboard Interface Specification</i> | Version 1.0, December 1997, Intel Corporation. | http://www.formfactors.org/developer/motherboard.htm |
| PCI | <i>PCI Local Bus Specification</i> | Revision 2.2, December 18, 1998, PCI Special Interest Group. | http://www.pcisig.com/specifications |
| | <i>PCI Bus Power Management Interface Specification</i> | Revision 1.1, December 18, 1998, PCI Special Interest Group. | http://www.pcisig.com/specifications |
| Plug and Play | <i>Plug and Play BIOS Specification</i> | Version 1.0a, May 5, 1994, Compaq Computer Corporation, Phoenix Technologies Limited, and Intel Corporation. | http://www.microsoft.com/hwdev/tech/PnP/default.msp x |
| PXE | <i>Preboot Execution Environment</i> | Version 2.1, September 20, 1999, Intel Corporation. | ftp://download.intel.com/labs/manage/wfm/download/pxespec.pdf |
| SFX | <i>SFX/SFX12V Power Supply Design Guide</i> | Version 2.0, May 2001, Intel Corporation. | http://www.formfactors.org/developer/specs/sfx/sfx12v.pdf |

continued

Table 3. Specifications (continued)

| Reference Name | Specification Title | Version, Revision Date and Ownership | The information is available from... |
|-----------------------|---|--|---|
| SMBIOS | <i>System Management BIOS</i> | Version 2.3.1, March 16, 1999, American Megatrends Incorporated, Award Software International Incorporated, Compaq Computer Corporation, Dell Computer Corporation, Hewlett-Packard Company, Intel Corporation, International Business Machines Corporation, Phoenix Technologies Limited, and SystemSoft Corporation. | http://www.dmtf.org/download/standards/DSP0119.pdf |
| TFX12V | <i>TFX12V Power Supply Design Guide</i> | Revision 1.01, May 2002 Intel Corporation | http://www.formfactors.org/developer/specs/tfx12v/tfx12v_psdg_101.pdf |
| UHCI | <i>Universal Host Controller Interface Design Guide</i> | Revision 1.1, March 1996, Intel Corporation. | http://developer.intel.com/design/USB/UHCI11D.htm |
| USB | <i>Universal Serial Bus Specification</i> | Revision 2.0, April 27, 2000, Compaq Computer Corporation, Hewlett-Packard Company, Lucent Technologies Inc., Intel Corporation, Microsoft Corporation, NEC Corporation, and Koninklijke Philips Electronics N.V. | http://www.usb.org/developers/docs.html |
| WfM | <i>Wired for Management Baseline</i> | Version 2.0, December 18, 1998, Intel Corporation. | http://www.intel.com/labs/manage/wfm/wfmspecs.htm |

1.6 Processor

NOTE

Refer to Thermal Considerations (Section 2.12, page 63) for important information when using an Intel Pentium 4 processor operating above 2.80 GHz with this Intel desktop board.

The board is designed to support the following:

- Intel Pentium 4 processors in an mPGA478 processor socket with a 533/400 MHz system bus
- Intel Celeron processors in an mPGA478 processor socket with a 400 MHz system bus

See the Intel web site listed below for the most up-to-date list of supported processors.

| For information about... | Refer to: |
|---|---|
| Supported processors for the D845GVSR board | http://www.intel.com/design/motherbd/sr/sr_proc.htm |



CAUTION

Use only the processors listed on web site above. Use of unsupported processors can damage the board, the processor, and the power supply.



INTEGRATOR'S NOTES

- *Use only ATX12V-, SFX12V-, or TFX12V-compliant power supplies with the Desktop Board D845GVSR. ATX12V, SFX12V, and TFX12V power supplies have an additional power lead that provides required supplemental power for the processor. Always connect the 20-pin and 4-pin leads of ATX12V, SFX12V, and TFX12V power supplies to the corresponding connectors on the desktop board, otherwise the board will not boot.*
- *Do not use a standard ATX power supply. The board will not boot with a standard ATX power supply.*
- *Refer to Table 4 on page 21 for a list of supported system bus frequency and memory speed combinations.*

| For information about | Refer to |
|-------------------------|--------------------------|
| Power supply connectors | Section 2.8.2.2, page 50 |

1.7 System Memory

The Desktop Board D845GVSR has two DIMM sockets and supports the following memory features:

- 2.5 V (only) 184-pin DDR SDRAM DIMMs with gold-plated contacts
- Unbuffered single-sided or double-sided DIMMs
- Maximum total system memory: 2 GB; minimum total system memory: 64 MB
- DDR333/266/200 MHz SDRAM DIMMs only
- Serial Presence Detect (SPD)
- Suspend to RAM

Table 4 lists the supported system bus frequency and memory speed combinations.

Table 4. Supported System Bus Frequency and Memory Speed Combinations

| If the processor's system bus frequency is... | You can use this type of DIMM... |
|---|----------------------------------|
| 533 MHz | DDR333 or DDR266 |
| 400 MHz | DDR266 or DDR200 |



CAUTION

Do not use ECC DIMMs with this board. Using ECC DIMMs could damage the board.



INTEGRATOR'S NOTES

- *Registered DIMMs are not supported.*
- *Double-sided x16 DIMMs are not supported.*



NOTE

To be fully compliant with all applicable DDR SDRAM memory specifications, the board should be populated with DIMMs that support the Serial Presence Detect (SPD) data structure. This allows the BIOS to read the SPD data and program the chipset to accurately configure memory settings for optimum performance.

| For information about | Refer to |
|---|----------------------|
| Obtaining DDR SDRAM specifications | Section 1.5, page 17 |
| Obtaining the PC Serial Presence Detect (SPD) Specification | Section 1.5, page 17 |

Table 5 lists the supported DDR DIMM configurations.

Table 5. Supported DDR DIMM Configurations

| DIMM Capacity | Configuration (Note) | DDR SDRAM Density | DDR SDRAM Organization Front-side/Back-side | Number of DDR SDRAM Devices |
|----------------------|-----------------------------|--------------------------|--|------------------------------------|
| 64 MB | SS | 64 Mbit | 8 M x 8/empty | 8 |
| 64 MB | SS | 128 Mbit | 8 M x 16/empty | 4 |
| 128 MB | DS | 64 Mbit | 8 M x 8/8 M x 8 | 16 |
| 128 MB | SS | 128 Mbit | 16 M x 8/empty | 8 |
| 128 MB | SS | 256 Mbit | 16 M x 16/empty | 4 |
| 256 MB | DS | 128 Mbit | 16 M x 8/16 M x 8 | 16 |
| 256 MB | SS | 256 Mbit | 32 M x 8/empty | 8 |
| 256 MB | SS | 512 Mbit | 32 M x 16/empty | 4 |
| 512 MB | DS | 256 Mbit | 32 M x 8/32 M x 8 | 16 |
| 512 MB | SS | 512 Mbit | 64 M x 8/empty | 8 |
| 1024 MB | DS | 512 Mbit | 64 M x 8/64 M x 8 | 16 |

Note: In this column, “DS” refers to double-sided memory modules (containing DDR SDRAM devices on both sides) and “SS” refers to single-sided memory modules (containing DDR SDRAM devices on only one side).

1.8 Intel® 845GV Chipset

The Intel 845GV chipset consists of the following devices:

- Intel 82845GV Graphics and Memory Controller Hub (GMCH) with Accelerated Hub Architecture (AHA) bus
- Intel 82801DB I/O Controller Hub (ICH4) with AHA bus
- Firmware Hub (FWH)

The GMCH is a centralized controller for the system bus, the memory bus, the AGP bus, and the Accelerated Hub Architecture interface. The ICH4 is a centralized controller for the board's I/O paths. The FWH provides the nonvolatile storage of the BIOS.

| For information about | Refer to |
|-------------------------------|---|
| The Intel 845GV chipset | http://developer.intel.com/ |
| Resources used by the chipset | Chapter 2 |

1.8.1 Intel® Extreme Graphics Controller

The Intel Extreme Graphics controller features the following:

- Integrated graphics controller
 - 32 bpp (Bits Per Pixel) graphics engine
 - 266 MHz core frequency
 - 256-bit internal data path for 2-D and 3-D graphics
 - Motion video acceleration
- 3-D graphics visual and texturing enhancement
- Display
 - Integrated 24-bit 350 MHz RAMDAC
 - DDC2B compliant interface
- Video
 - Dual monitor synchronous display
 - Hardware motion compensation for software MPEG2 decode
- Dynamic Video Memory Technology (DVMT) support up to 64 MB

| For information about | Refer to |
|-----------------------|--------------------------|
| DVMT | Section 1.8.1.1, page 27 |

Table 6 lists the Direct Draw supported modes.

Table 6. Direct Draw Supported Modes

| Resolution | Color Palette | Refresh Frequency (Hz) | Notes |
|------------|---------------|------------------------|-------|
| 320 x 200 | 256 colors | 70 | Y |
| | 64 K colors | 70 | 3 |
| | 16 M colors | 70 | 3 |
| 320 x 240 | 256 colors | 70 | Y |
| | 64 K colors | 70 | 3 |
| | 16 M colors | 70 | 3 |
| 352 x 480 | 256 colors | 70 | Y |
| | 64 K colors | 70 | 3 |
| | 16 M colors | 70 | 3 |
| 352 x 576 | 256 colors | 70 | Y |
| | 64 K colors | 70 | 3 |
| | 16 M colors | 70 | 3 |
| 400 x 300 | 256 colors | 70 | Y |
| | 64 K colors | 70 | 3 |
| | 16 M colors | 70 | 3 |
| 512 x 384 | 256 colors | 70 | Y |
| | 64 K colors | 70 | 3 |
| | 16 M colors | 70 | 3 |
| 640 x 400 | 256 colors | 70 | Y |
| | 64 K colors | 70 | 3 |
| | 16 M colors | 70 | 3 |

Notes: Y = Supported in driver without Direct3D[†] and OpenGL[†]
 3 = Direct3D and OpenGL

Table 7 lists the video BIOS video modes supported by the graphics subsystem.

Table 7. Video BIOS Video Modes Supported for Analog CRTs

| Resolution | Color Palette | Available Refresh Frequencies (Hz) | Notes |
|-------------------|----------------------|---|--------------|
| 320 x 200 | 16 colors | 70 | T, G, B |
| | 256 colors | 70 | G, B |
| 320 x 350 | 16 colors | 70 | T, B |
| 360 x 400 | 16 colors | 70 | T, B |
| 640 x 200 | 16 colors | 70 | T, G, B |
| 640 x 350 | 16 colors | 70 | T, G, B |
| 640 x 480 | 16 colors | 60 | G, B |
| | 256 colors | 60, 75, 85 | G, B, L |
| | 64 K colors | 60, 75, 85 | G, B, L |
| | 16 M colors | 60, 75, 85 | G, B, L |
| 720 x 400 | 16 colors | 70 | T, B |
| 800 x 600 | 256 colors | 60, 75, 85 | G, B, L |
| | 64 K colors | 60, 75, 85 | G, B, L |
| | 16 M colors | 60, 75, 85 | G, B, L |
| 1024 x 768 | 256 colors | 60, 75, 85 | G, B, L |
| | 64 K colors | 60, 75, 85 | G, B, L |
| | 16 M colors | 60, 75, 85 | G, B, L |
| 1056 x 350 | 16 colors | 70 | T, B |
| 1056 x 400 | 16 colors | 70 | T, B |
| 1056 x 480 | 16 colors | 70 | T, B |
| 1280 x 1024 | 256 colors | 60, 75, 85 | G, B, L |
| | 64 K colors | 60, 75, 85 | G, B, L |
| | 16 M colors | 60, 75, 85 | G, B, L |
| 1600 x 1200 | 256 colors | 60, 75, 85 | G, B, L |
| | 64 K colors | 60, 75, 85 | G, B, L |
| | 16 M colors | 60, 75, 85 | G, B, L |
| 1920 x 1440 | 256 colors | 60, 75 | G, B, L |
| | 64 K colors | 60, 75 | G, B, L |

Notes: T = Text mode
 G = Graphics mode
 B = Banked addressing mode
 L = Linear addressing mode

Table 8 lists the supported configuration modes of the graphics subsystem.

Table 8. Supported Configuration Modes

| Resolution | Available Refresh Frequencies (Hz) | Supported bpp Configuration Mode (see Table 9 for more information) |
|-------------------|---|--|
| 640 x 480 | 60, 72, 75, 85, 100, 120 | 6 |
| 800 x 600 | 60, 72, 75, 85, 100, 120 | 6 |
| 1024 x 768 | 60, 70, 75, 85, 100 | 6 |
| 1024 x 768 | 120 | 5 |
| 1152 x 864 | 60, 75, 85 | 6 |
| 1152 x 864 | 100 | 5 |
| 1280 x 720 | 60, 75, 85 | 6 |
| 1280 x 720 | 100 | 5 |
| 1280 x 768 | Reduced blanking | 6 |
| 1280 x 960 | 60, 75 | 6 |
| 1280 x 960 | 85 | 5 |
| 1280 x 1024 | 60 | 6 |
| 1280 x 1024 | 75 | 5 |
| 1280 x 1024 | 85, 100 | 4 |
| 1280 x 1024 | 120 | 3 |
| 1400 x 1050 | 60 | 6 |
| 1600 x 900 | 60 | 6 |
| 1600 x 900 | 75, 85 | 4 |
| 1600 x 900 | 100 | 3 |
| 1600 x 1200 | 60 | 4 |
| 1600 x 1200 | 75, 85, 100 | 3 |
| 1856 x 1392 | 60, 75 | 3 |
| 1920 x 1080 | 60 | 4 |
| 1920 x 1080 | 75, 85 | 3 |
| 1920 x 1200 | 60 | 3 |
| 1920 x 1440 | 60, 75 | 3 |
| 2048 x 1536 | 60 | 3 |

Table 9 describes the bpp configuration mode values referenced in Table 8. In Table 9, assume that for each configuration mode number, the features of all lower numbers are also supported. For example, if the supported configuration mode is 4, then modes 1 through 3 are also supported. DVD consists of both the overlay engine as well as the MPEG decoding; both are necessary for DVD playback.

Table 9. Details of bpp Configuration Modes

| Configuration Mode Number | Description |
|---------------------------|--|
| 6 | 32 bpp (16 M colors) with DVD (Overlay + MPEG decode) On |
| 5 | 16 bpp (64 K colors) with DVD On |
| 4 | 32 bpp (16 M colors) with DVD Off |
| 3 | 16 bpp (64 K colors) with DVD Off |
| 2 | 8 bpp (256 colors) with DVD On |
| 1 | 8 bpp (256 colors) with DVD off |

| For information about | Refer to |
|---|----------------------|
| Obtaining graphics software and utilities | Section 1.3, page 16 |

1.8.1.1 Dynamic Video Memory Technology (DVMT)

DVMT enables enhanced graphics and memory performance through Direct AGP, and highly efficient memory utilization. DVMT ensures the most efficient use of available system memory (up to 64 MB) for maximum 2-D/3-D graphics performance.

DVMT uses a portion of system physical memory (as set in the BIOS Setup program) for compatibility with legacy applications. An example of this would be when using VGA graphics under DOS. Once loaded, the operating system and graphics drivers allocate the buffers needed for performing graphics functions.

NOTE

The use of DVMT requires operating system driver support.

| For information about | Refer to |
|--------------------------------|---|
| Obtaining the DVMT white paper | http://developer.intel.com/design/chipsets/845gv/ |

1.8.1.2 Zone Rendering Technology (ZRT)

The Intel Extreme Graphics Controller supports Zone Rendering Technology (ZRT). ZRT is a process by which the screen is divided into several zones. Each zone is completely cached and rendered on chip before being written to the frame buffer. The benefits of ZRT include the following:

- Increased memory efficiency via better localization of data
- Increased on-chip processing speed due to decreased wait time for data
- Increased effective pixel fill rates

- Increased headroom for larger resolution and color depth
- Reduced power as a result of decreased memory bandwidth
- Reduction in depth and color bandwidth associated with conventional rendering

For information about

Refer to

Obtaining the Zone Rendering white paper

<http://developer.intel.com/design/chipsets/845gv/>

1.8.2 USB

The board supports up to six USB 2.0 ports, fully supports UHCI and EHCI, and uses UHCI- and EHCI-compatible drivers. For more than six USB devices, an external hub can be connected to any of the ports.

The ICH4 provides the USB controller for all ports. The port arrangement is as follows:

- Two ports are implemented with stacked back panel connectors, adjacent to the PS/2 connectors
- Two ports are implemented with stacked back panel connectors, adjacent to the audio connectors
- Two ports are routed to the front panel USB connector



NOTE

Computer systems that have an unshielded cable attached to a USB port may not meet FCC Class B requirements, even if no device is attached to the cable. Use shielded cable that meets the requirements for full-speed devices.

1.8.3 IDE Interfaces

The ICH4's IDE controller has two independent bus-mastering IDE interfaces that can be independently enabled. The IDE interfaces support the following modes:

- Programmed I/O (PIO): processor controls data transfer.
- 8237-style DMA: DMA offloads the processor, supporting transfer rates of up to 16 MB/sec.
- Ultra DMA: DMA protocol on IDE bus supporting host and target throttling and transfer rates of up to 33 MB/sec.
- ATA-66: DMA protocol on IDE bus supporting host and target throttling and transfer rates of up to 66 MB/sec. ATA-66 protocol is similar to Ultra DMA and is device driver compatible.
- ATA-100: DMA protocol on IDE bus allows host and target throttling. The ICH4's ATA-100 logic can achieve transfer rates up to 100 MB/sec.

 INTEGRATOR'S NOTE

ATA-66 and ATA-100 are faster timings and require a specialized cable to reduce reflections, noise, and inductive coupling.

The IDE interfaces also support ATAPI devices (such as CD-ROM drives) and ATA devices.

The BIOS supports 48-bit Logical Block Addressing (LBA) and Extended Cylinder Head Sector (ECHS) translation modes. The drive reports the transfer rate and translation mode to the BIOS.

The Desktop Boards support Laser Servo (LS-120) diskette technology through the IDE interfaces. The BIOS supports booting from an LS-120 drive.

 NOTE

The BIOS will always recognize an LS-120 drive as an ATAPI floppy drive. To ensure correct operation, do not configure the drive as a hard disk drive.

1.8.4 Real-Time Clock, CMOS SRAM, and Battery

A coin-cell battery (CR2032) powers the real-time clock and CMOS memory. When the computer is not plugged into a wall socket, the battery has an estimated life of three years. When the computer is plugged in, the standby current from the power supply extends the life of the battery. The clock is accurate to ± 13 minutes/year at 25 °C with 3.3 VSB applied.

 INTEGRATOR'S NOTE

If the battery and AC power fail, custom defaults, if previously saved, will be loaded into CMOS RAM at power-on.

1.9 I/O Controller

The SMSC LPC47M172 or National Semiconductor PC87372 I/O controller provides the following features:

- One serial port
- One parallel port with Extended Capabilities Port (ECP) and Enhanced Parallel Port (EPP) support
- Serial IRQ interface compatible with serialized IRQ support for PCI systems
- PS/2-style mouse and keyboard interfaces
- Interface for one 1.44 MB or 2.88 MB diskette drive
- Intelligent power management, including a programmable wake-up event interface
- PCI power management support

The BIOS Setup program provides configuration options for the I/O controller.

| For information about | Refer to |
|--------------------------------|---|
| SMSC LPC47M172 I/O controller | http://www.smSC.com |
| National Semiconductor PC87372 | http://www.national.com |

1.9.1 Serial Ports

The Desktop Board has two serial port connectors. Serial port A is located on the back panel. Serial port B (optional) is accessible using a connector on the component side of the Desktop Board. The serial ports support data transfers at speeds up to 115.2 kbits/sec with BIOS support.

| For information about | Refer to |
|--|-------------------|
| The location of the serial port A connector | Figure 4, page 48 |
| The location of the optional serial port B connector | Figure 7, page 54 |

1.9.2 Parallel Port

The 25-pin D-Sub parallel port connector is located on the back panel. Use the BIOS Setup program to set the parallel port mode.

1.9.3 Diskette Drive Controller

The I/O controller supports one diskette drive. Use the BIOS Setup program to configure the diskette drive interface.

1.9.4 Keyboard and Mouse Interface

PS/2 keyboard and mouse connectors are located on the back panel.

INTEGRATOR'S NOTE

The keyboard is supported in the bottom PS/2 connector and the mouse is supported in the top PS/2 connector. Power to the computer should be turned off before a keyboard or mouse is connected or disconnected.

1.10 Audio Subsystem

The audio subsystem consists of the following devices:

- Intel 82801DB I/O Controller Hub (ICH4)
- Realtek ALC202A audio codec

The audio subsystem includes these features:

- Signal-to-noise ratio ≥ 90 dB
- Supports wake events (driver dependent)
- Mic in pre-amp that supports dynamic, condenser, and electret microphones

The audio subsystem supports the following audio interfaces:

- ATAPI-style connectors:
 - Auxiliary line in
 - CD-ROM
- Front panel audio connector, including pins for:
 - Line out
 - Mic in
- Back panel audio connectors:
 - Line out
 - Line in
 - Mic in

1.10.1 Audio Connectors

1.10.1.1 Front Panel Audio Connector

A 2 x 5-pin connector provides mic in and line out signals for front panel audio connectors.

| For information about | Refer to |
|--|----------------------|
| The location of the connector | Figure 5, page 50 |
| The signal names of the front panel audio connector | Table 21, page 51 |
| Obtaining the <i>Front Panel I/O Connectivity Design Guide</i> | Section 1.5, page 17 |

NOTE

The front panel audio connector is alternately used as a jumper block for routing audio signals. Refer to Section 2.9.1 on page 58 for more information.

1.10.1.2 Auxiliary Line In Connector

A 1 x 4-pin ATAPI-style connector connects the left and right channel signals of an internal audio device to the audio subsystem.

| For information about | Refer to |
|---|-------------------|
| The location of the auxiliary line in connector | Figure 5, page 50 |
| The signal names of the auxiliary line in connector | Table 22, page 51 |

1.10.1.3 ATAPI CD-ROM Audio Connector

A 1 x 4-pin ATAPI-style connector connects an internal ATAPI CD-ROM drive to the audio mixer.

| For information about | Refer to |
|--|-------------------|
| The location of the ATAPI CD-ROM connector | Figure 5, page 50 |
| The signal names of the ATAPI CD-ROM connector | Table 23, page 51 |

1.10.2 Audio Subsystem Software

Audio software and drivers are available from Intel's World Wide Web site.

| For information about | Refer to |
|--------------------------------------|----------------------|
| Obtaining audio software and drivers | Section 1.3, page 16 |

1.11 LAN Subsystem (Optional)

The Network Interface Controller subsystem consists of the ICH4 (with integrated LAN Media Access Controller) and a physical layer interface device. Features of the LAN subsystem include:

- PCI Bus Master interface
- CSMA/CD Protocol Engine
- Serial CSMA/CD unit interface that supports the 82562ET (10/100 Mbit/sec Ethernet)
- PCI Power Management
 - Supports ACPI technology
 - Supports LAN wake capabilities

1.11.1 Intel® 82562ET Platform LAN Connect Device

The Intel 82562ET component provides an interface to the back panel RJ-45 connector with integrated LEDs.

The Intel 82562ET provides the following functions:

- Basic 10/100 Ethernet LAN connectivity
- Supports RJ-45 connector with status indicator LEDs on the back panel
- Full device driver compatibility
- ACPI support
- Programmable transit threshold
- Configuration EEPROM that contains the MAC address

1.11.2 RJ-45 LAN Connector with Integrated LEDs

Two LEDs are built into the RJ-45 LAN connector. Table 10 describes the LED states when the Desktop Board is powered up and the LAN subsystem is operating.

Table 10. LAN Connector LED States

| LED Color | LED State | Condition |
|-----------|---------------------------|---|
| Green | Off | 10 Mbit/sec data rate is selected. |
| | On | 100 Mbit/sec data rate is selected. |
| Yellow | Off | LAN link is not established. |
| | On (steady state) | LAN link is established. |
| | On (brighter and pulsing) | The computer is communicating with another computer on the LAN. |

1.11.3 LAN Subsystem Software

LAN software and drivers are available from Intel's World Wide Web site.

| For information about | Refer to |
|------------------------------------|----------------------|
| Obtaining LAN software and drivers | Section 1.3, page 16 |

1.12 Hardware Management Subsystem (Optional)

The hardware management features enable the boards to be compatible with the Wired for Management (WfM) specification. The board has several hardware management features, including the following:

- Fan monitoring (through the I/O controller or the hardware monitoring and fan control ASIC)
- Thermal and voltage monitoring
- Chassis intrusion detection

| For information about | Refer to |
|-----------------------|----------------------|
| The WfM specification | Section 1.5, page 17 |

1.12.1 Hardware Monitoring and Fan Control ASIC

The features of the hardware monitoring and fan control ASIC include:

- Internal ambient temperature sensor
- Two remote thermal diode sensors for direct monitoring of processor temperature and ambient temperature sensing
- Power supply monitoring of five voltages (+5 V, +12 V, +3.3 VSB, +1.5 V, and +VCCP) to detect levels above or below acceptable values
- Thermally monitored closed-loop fan control, for all three fans, that can adjust the fan speed or switch the fans on or off as needed
- SMBus interface
- Fan monitoring for all three fan connectors

1.12.2 Fan Monitoring

Fan monitoring can be implemented using Intel® LANDesk Client Manager or third-party software.

| For information about | Refer to |
|-------------------------------------|---------------------------|
| The functions of the fan connectors | Section 1.13.2.2, page 38 |

1.12.3 Chassis Intrusion and Detection

The board supports a chassis security feature that detects if the chassis cover is removed. The security feature uses a mechanical switch on the chassis that attaches to the chassis intrusion connector. When the chassis cover is removed, the mechanical switch is in the closed position.

1.13 Power Management

Power management is implemented at several levels, including:

- Software support through Advanced Configuration and Power Interface (ACPI)
- Hardware support:
 - Power connector
 - Fan connectors
 - LAN wake capabilities
 - Instantly Available PC technology
 - Resume on Ring
 - Wake from USB
 - Wake from PS/2 devices
 - Power Management Event signal (PME#) wake-up support

1.13.1 ACPI

ACPI gives the operating system direct control over the power management and Plug and Play functions of a computer. The use of ACPI with this board requires an operating system that provides full ACPI support. ACPI features include:

- Plug and Play (including bus and device enumeration)
- Power management control of individual devices, add-in boards (some add-in boards may require an ACPI-aware driver), video displays, and hard disk drives
- Methods for achieving less than 15-watt system operation in the power-on/standby sleeping state
- A Soft-off feature that enables the operating system to power-off the computer
- Support for multiple wake-up events (see Table 13 on page 36)
- Support for a front panel power and sleep mode switch

Table 11 lists the system states based on how long the power switch is pressed, depending on how ACPI is configured with an ACPI-aware operating system.

Table 11. Effects of Pressing the Power Switch

| If the system is in this state... | ...and the power switch is pressed for | ...the system enters this state |
|--|---|--|
| Off (ACPI G2/G5 – Soft off) | Less than four seconds | Power-on (ACPI G0 – working state) |
| On (ACPI G0 – working state) | Less than four seconds | Soft-off/Standby (ACPI G1 – sleeping state) |
| On (ACPI G0 – working state) | More than four seconds | Fail safe power-off (ACPI G2/G5 – Soft off) |
| Sleep (ACPI G1 – sleeping state) | Less than four seconds | Wake-up (ACPI G0 – working state) |
| Sleep (ACPI G1 – sleeping state) | More than four seconds | Power-off (ACPI G2/G5 – Soft off) |

For information about

The Desktop Boards' compliance level with ACPI

Refer to

Section 1.5, page 17

1.13.1.1 System States and Power States

Under ACPI, the operating system directs all system and device power state transitions. The operating system puts devices in and out of low-power states based on user preferences and knowledge of how devices are being used by applications. Devices that are not being used can be turned off. The operating system uses information from applications and user settings to put the system as a whole into a low-power state.

Table 12 lists the power states supported by the Desktop Board D845GVSR along with the associated system power targets. See the ACPI specification for a complete description of the various system and power states.

Table 12. Power States and Targeted System Power

| Global States | Sleeping States | Processor States | Device States | Targeted System Power ^(Note 1) |
|--|--|------------------|--|--|
| G0 – working state | S0 – working | C0 – working | D0 – working state. | Full power > 30 W |
| G1 – sleeping state | S1 – Processor stopped | C1 – stop grant | D1, D2, D3 – device specification specific. | 5 W < power < 52.5 W |
| G1 – sleeping state | S3 – Suspend to RAM. Context saved to RAM. | No power | D3 – no power except for wake-up logic. | Power < 5 W ^(Note 2) |
| G1 – sleeping state | S4 – Suspend to disk. Context saved to disk. | No power | D3 – no power except for wake-up logic. | Power < 5 W ^(Note 2) |
| G2/S5 | S5 – Soft off. Context not saved. Cold boot is required. | No power | D3 – no power except for wake-up logic. | Power < 5 W ^(Note 2) |
| G3 – mechanical off AC power is disconnected from the computer. | No power to the system. | No power | D3 – no power for wake-up logic, except when provided by battery or external source. | No power to the system. Service can be performed safely. |

Notes:

1. Total system power is dependent on the system configuration, including add-in boards and peripherals powered by the system chassis' power supply.
2. Dependent on the standby power consumption of wake-up devices used in the system.

1.13.1.2 Wake-up Devices and Events

Table 13 lists the devices or specific events that can wake the computer from specific states.

Table 13. Wake-up Devices and Events

| These devices/events can wake up the computer... | ...from this state |
|--|----------------------------------|
| LAN | S1, S3, S4, S5 ^(Note) |
| Modem (back panel Serial Port A) | S1, S3 |
| PME# signal | S1, S3, S4, S5 ^(Note) |
| Power switch | S1, S3, S4, S5 |
| PS/2 devices | S1, S3 |
| RTC alarm | S1, S3, S4, S5 |
| USB | S1, S3 |

Note: For LAN and PME# signal, S5 is disabled by default in the BIOS Setup program. Setting this option to Power On will enable a wake-up event from LAN in the S5 state.

 **NOTE**

The use of these wake-up events from an ACPI state requires an operating system that provides full ACPI support. In addition, software, drivers, and peripherals must fully support ACPI wake events.

1.13.2 Hardware Support

 **CAUTION**

Ensure that the power supply provides adequate +5 V standby current if LAN wake capabilities and Instantly Available PC technology features are used. Failure to do so can damage the power supply. The total amount of standby current required depends on the wake devices supported and manufacturing options.

The Desktop Board D845GVSR provides several power management hardware features, including:

- Power connector
- Fan connectors
- LAN wake capabilities
- Instantly Available PC technology
- Resume on Ring
- Wake from USB
- Wake from PS/2 keyboard
- PME# signal wake-up support

LAN wake capabilities and Instantly Available PC technology require power from the +5 V standby line. The sections discussing these features describe the incremental standby power requirements for each.

Resume on Ring enables telephony devices to access the computer when it is in a power-managed state. The method used depends on the type of telephony device (external or internal).

 **NOTE**

The use of Resume on Ring and Wake from USB technologies from an ACPI state requires an operating system that provides full ACPI support.

1.13.2.1 Power Connector

ATX12V-, SFX12V-, and TFX12V-compliant power supplies can turn off the system power through system control. When an ACPI-enabled system receives the correct command, the power supply removes all non-standby voltages.

When resuming from an AC power failure, the computer returns to the power state it was in before power was interrupted (on or off). The computer's response can be set using the Last Power State feature in the BIOS Setup program's Boot menu.

| For information about | Refer to |
|---|----------------------|
| The location of the power connector | Figure 5, page 50 |
| The signal names of the power connector | Table 27, page 52 |
| The BIOS Setup program's Boot menu | Table 64, page 96 |
| The ATX, SFX, and TFX12V specifications | Section 1.5, page 17 |

1.13.2.2 Fan Connectors

Table 14 summarizes the function/operation of the fan connectors.

Table 14. Fan Connector Function/Operation

| Connector | Description |
|-------------------|--|
| Processor fan | <ul style="list-style-type: none"> +12 V DC connection for a processor fan or active fan heatsink. Fan is on in the S0 or S1 state. Fan is off when the system is off or in the S3, S4, or S5 state. Option to wire the fan tachometer input to the I/O controller or the Hardware Monitoring and Fan Control ASIC. |
| Front chassis fan | <ul style="list-style-type: none"> +12 V DC connection for a system or chassis fan. Fan is on in the S0 or S1 state. Fan is off when the system is off or in the S3, S4, or S5 state. Option to wire the fan tachometer input to the Hardware Monitoring and Fan Control ASIC. |
| Rear chassis fan | <ul style="list-style-type: none"> +12 V DC connection for a system or chassis fan. Fan is on in the S0 or S1 state. Fan is off when the system is off or in the S3, S4, or S5 state. Option to wire the fan tachometer input to the I/O controller or the Hardware Monitoring and Fan Control ASIC. |

1.13.2.3 LAN Wake Capabilities



CAUTION

For LAN wake capabilities, the +5 V standby line for the power supply must be capable of providing adequate +5 V standby current. Failure to provide adequate standby current when implementing LAN wake capabilities can damage the power supply.

LAN wake capabilities enable remote wake-up of the computer through a network. The LAN subsystem PCI bus network adapter monitors network traffic at the Media Independent Interface. Upon detecting a Magic Packet[†] frame, the LAN subsystem asserts a wake-up signal that powers up the computer. Depending on the LAN implementation, the board supports LAN wake capabilities with ACPI in the following ways:

- The PCI bus PME# signal for PCI 2.2 compliant LAN designs
- The onboard LAN subsystem

1.13.2.4 Instantly Available PC Technology



CAUTION

For Instantly Available PC technology, the +5 V standby line for the power supply must be capable of providing adequate +5 V standby current. Failure to provide adequate standby current when implementing Instantly Available PC technology can damage the power supply.

Instantly Available PC technology enables the board to enter the ACPI S3 (Suspend-to-RAM) sleep-state. While in the S3 sleep-state, the computer will appear to be off (the power supply is off, and the front panel LED is amber if dual colored, or off if single colored.) When signaled by a wake-up device or event, the system quickly returns to its last known wake state. Table 13 on page 36 lists the devices and events that can wake the computer from the S3 state.

The board supports the *PCI Bus Power Management Interface Specification*. For information on the version of this specification, see Section 1.5.

Add-in boards that also support this specification can participate in power management and can be used to wake the computer.

The use of Instantly Available PC technology requires operating system support and PCI 2.2 compliant add-in cards and drivers.

1.13.2.5 +5 V Standby Power Indicator LED

The +5 V standby power indicator LED shows that power is still present even when the computer appears to be off. Figure 3 shows the location of the standby power indicator LED.



CAUTION

If AC power has been switched off and the standby power indicator is still lit, disconnect the power cord before installing or removing any devices connected to the board. Failure to do so could damage the board and any attached devices.

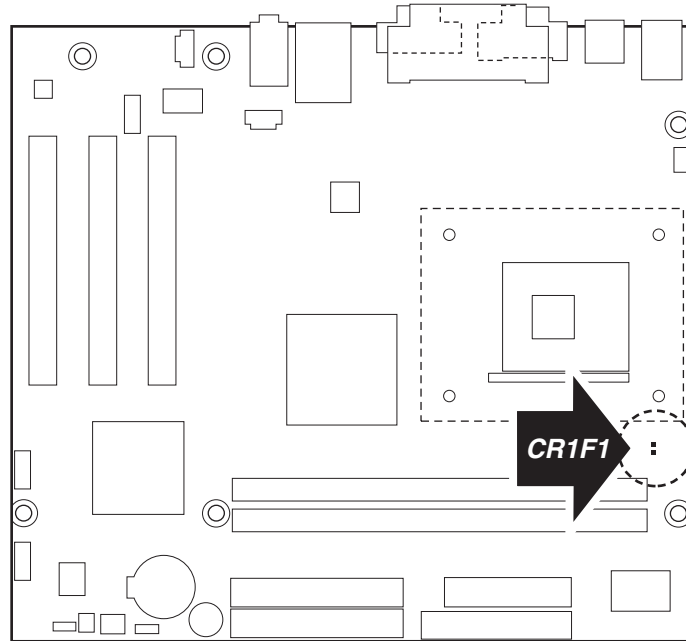

OM16234

Figure 3. Location of the Standby Power Indicator LED on the D845GVSR Board

1.13.2.6 Resume on Ring

The operation of Resume on Ring can be summarized as follows:

- Resumes operation from ACPI S1 or S3 states
- Detects incoming call similarly for external and internal modems
- Requires modem interrupt be unmasked for correct operation

1.13.2.7 Wake from USB

USB bus activity wakes the computer from ACPI S1 or S3 states.

NOTE

Wake from USB requires the use of a USB peripheral that supports Wake from USB.

1.13.2.8 Wake from PS/2 Devices

PS/2 device activity wakes the computer from an ACPI S1 or S3 state.

1.13.2.9 PME# Signal Wake-up Support

When the PME# signal on the PCI bus is asserted, the computer wakes from an ACPI S1, S3, S4, or S5 state (with Wake on PME enabled in BIOS).

2 Technical Reference

What This Chapter Contains

| | | |
|------|-----------------------------------|----|
| 2.1 | Introduction..... | 41 |
| 2.2 | Memory Map | 41 |
| 2.3 | Fixed I/O Map..... | 42 |
| 2.4 | DMA Channels | 43 |
| 2.5 | PCI Configuration Space Map | 43 |
| 2.6 | Interrupts | 44 |
| 2.7 | PCI Interrupt Routing Map..... | 45 |
| 2.8 | Connectors..... | 47 |
| 2.9 | Jumper Blocks..... | 58 |
| 2.10 | Mechanical Considerations..... | 60 |
| 2.11 | Electrical Considerations | 62 |
| 2.12 | Thermal Considerations..... | 63 |
| 2.13 | Reliability | 65 |
| 2.14 | Environmental | 65 |

2.1 Introduction

Sections 2.2 - 2.6 contain several standalone tables. Table 15 describes the system memory map, Table 16 shows the I/O map, Table 17 lists the DMA channels, Table 18 defines the PCI configuration space map, and Table 19 describes the interrupts. The remaining sections in this chapter are introduced by text found with their respective section headings.

2.2 Memory Map

Table 15. System Memory Map

| Address Range (decimal) | Address Range (hex) | Size | Description |
|-------------------------|---------------------|---------|---|
| 1024 K - 2097152 K | 100000 - 7FFFFFFF | 2047 MB | Extended memory |
| 960 K - 1024 K | F0000 - FFFFF | 64 KB | Runtime BIOS |
| 896 K - 960 K | E0000 - EFFFF | 64 KB | Reserved |
| 800 K - 896 K | C8000 - DFFFF | 96 KB | Available high DOS memory (open to the PCI bus) |
| 640 K - 800 K | A0000 - C7FFF | 160 KB | Video memory and BIOS |
| 639 K - 640 K | 9FC00 - 9FFFF | 1 KB | Extended BIOS data (movable by memory manager software) |
| 512 K - 639 K | 80000 - 9FBFF | 127 KB | Extended conventional memory |
| 0 K - 512 K | 00000 - 7FFFF | 512 KB | Conventional memory |

2.3 Fixed I/O Map

Table 16. I/O Map

| Address (hex) | Size | Description |
|----------------------|-----------|--|
| 0000 - 00FF | 256 bytes | Used by the Desktop Board D845GVSR. Refer to the ICH4 data sheet for dynamic addressing information. |
| 0170 - 0177 | 8 bytes | Secondary IDE channel |
| 01F0 - 01F7 | 8 bytes | Primary IDE channel |
| 0228 - 022F (Note 1) | 8 bytes | LPT3 |
| 0278 - 027F (Note 1) | 8 bytes | LPT2 |
| 02E8 - 02EF (Note 1) | 8 bytes | COM4 |
| 02F8 - 02FF (Note 1) | 8 bytes | COM2 |
| 0376 | 1 byte | Secondary IDE channel command port |
| 0377, bits 6:0 | 7 bits | Secondary IDE channel status port |
| 0378 - 037F | 8 bytes | LPT1 |
| 03B0 - 03BB | 12 bytes | Intel 82845GV GMCH |
| 03C0 - 03DF | 32 bytes | Intel 82845GV GMCH |
| 03E8 - 03EF | 8 bytes | COM3 |
| 03F0 - 03F5 | 6 bytes | Diskette channel 1 |
| 03F6 | 1 byte | Primary IDE channel command port |
| 03F8 - 03FF | 8 bytes | COM1 |
| 04D0 - 04D1 | 2 bytes | Edge/level triggered PIC |
| LPTn + 400 | 8 bytes | ECP port, LPTn base address + 400h |
| 0CF8 - 0CFB (Note 2) | 4 bytes | PCI configuration address register |
| 0CF9 (Note 3) | 1 byte | Turbo and reset control register |
| 0CFC - 0CFF | 4 bytes | PCI configuration data register |
| FFA0 - FFA7 | 8 bytes | Primary bus master IDE registers |
| FFA8 - FFAF | 8 bytes | Secondary bus master IDE registers |

Notes:

1. Default, but can be changed to another address range
2. Dword access only
3. Byte access only



NOTE

Some additional I/O addresses are not available due to ICH4 address aliasing. The ICH4 data sheet provides more information on address aliasing.

For information about

Obtaining the ICH4 data sheet

Refer to

Section 1.3 on page 16

2.4 DMA Channels

Table 17. DMA Channels

| DMA Channel Number | Data Width | System Resource |
|--------------------|--------------|--------------------------------|
| 0 | 8 or 16 bits | Open |
| 1 | 8 or 16 bits | Parallel port |
| 2 | 8 or 16 bits | Diskette drive |
| 3 | 8 or 16 bits | Parallel port (for ECP or EPP) |
| 4 | 8 or 16 bits | DMA controller |
| 5 | 16 bits | Open |
| 6 | 16 bits | Open |
| 7 | 16 bits | Open |

2.5 PCI Configuration Space Map

Table 18. PCI Configuration Space Map

| Bus Number (hex) | Device Number (hex) | Function Number (hex) | Description |
|------------------|---------------------|-----------------------|--|
| 00 | 00 | 00 | Memory controller of Intel 82845GV component |
| 00 | 02 | 00 | Intel Extreme Graphics Controller |
| 00 | 1E | 00 | Hub link to PCI bridge |
| 00 | 1F | 00 | Intel 82801DB ICH4 PCI to LPC bridge |
| 00 | 1F | 01 | IDE controller |
| 00 | 1F | 03 | SMBus controller |
| 00 | 1F | 05 | AC '97 audio controller |
| 00 | 1F | 06 | AC '97 modem controller (optional) |
| 00 | 1D | 00 | USB UHCI controller 1 |
| 00 | 1D | 01 | USB UHCI controller 2 |
| 00 | 1D | 02 | USB UHCI controller 3 |
| 00 | 1D | 07 | EHCI controller |
| 01 | 08 | 00 | LAN controller (optional) |
| 01 | 00 | 00 | PCI bus connector 1 |
| 01 | 01 | 00 | PCI bus connector 2 |
| 01 | 02 | 00 | PCI bus connector 3 |

2.6 Interrupts

The interrupts can be routed through either the Programmable Interrupt Controller (PIC) or the Advanced Programmable Interrupt Controller (APIC) portion of the ICH4 component. The PIC is supported in Windows 98 SE and Windows ME and uses the first 16 interrupts. The APIC is supported in Windows 2000 and Windows XP and supports a total of 24 interrupts.

Table 19. Interrupts

| IRQ | System Resource |
|-------------|---|
| NMI | I/O channel check |
| 0 | Reserved, interval timer |
| 1 | Reserved, keyboard buffer full |
| 2 | Reserved, cascade interrupt from slave PIC |
| 3 | COM2 (Note 1) |
| 4 | COM1 (Note 1) |
| 5 | LPT2 (Plug and Play option)/User available |
| 6 | Diskette drive |
| 7 | LPT1 (Note 1) |
| 8 | Real-time clock |
| 9 | Reserved for ICH4 system management bus |
| 10 | User available |
| 11 | User available |
| 12 | Onboard mouse port (if present, else user available) |
| 13 | Reserved, math coprocessor |
| 14 | Primary IDE (if present, else user available) |
| 15 | Secondary IDE (if present, else user available) |
| 16 (Note 2) | USB UHCI controller 1 (through PIRQA) |
| 17 (Note 2) | AC '97 audio/modem/User available (through PIRQB) |
| 18 (Note 2) | ICH4 USB controller 3 (through PIRQC) |
| 19 (Note 2) | ICH4 USB controller 2 (through PIRQD) |
| 20 (Note 2) | ICH4 LAN (optional) (through PIRQE) |
| 21 (Note 2) | User available (through PIRQF) |
| 22 (Note 2) | User available (through PIRQG) |
| 23 (Note 2) | ICH4 USB 2.0 EHCI controller/User available (through PIRQH) |

Notes:

1. Default, but can be changed to another IRQ.
2. Available in APIC mode only.

2.7 PCI Interrupt Routing Map

This section describes interrupt sharing and how the interrupt signals are connected between the PCI bus connectors and onboard PCI devices. The PCI specification specifies how interrupts can be shared between devices attached to the PCI bus. In most cases, the small amount of latency added by interrupt sharing does not affect the operation or throughput of the devices. In some special cases where maximum performance is needed from a device, a PCI device should not share an interrupt with other PCI devices. Use the following information to avoid sharing an interrupt with a PCI add-in card.

PCI devices are categorized as follows to specify their interrupt grouping:

- **INTA:** By default, all add-in cards that require only one interrupt are in this category. For almost all cards that require more than one interrupt, the first interrupt on the card is also classified as INTA.
- **INTB:** Generally, the second interrupt on add-in cards that require two or more interrupts is classified as INTB. (This is not an absolute requirement.)
- **INTC and INTD:** Generally, a third interrupt on add-in cards is classified as INTC and a fourth interrupt is classified as INTD.

The ICH4 has eight Programmable Interrupt Request (PIRQ) input signals. All PCI interrupt sources either onboard or from a PCI add-in card connect to one of these PIRQ signals. Some PCI interrupt sources are electrically tied together on the Desktop Board D845GVSR and therefore share the same interrupt. Table 20 shows an example of how the PIRQ signals are routed.

For example, using Table 20 as a reference, assume an add-in card using INTA is plugged into PCI bus connector 3. In PCI bus connector 3, INTA is connected to PIRQC, which is already connected to the ICH4 USB. The add-in card in PCI bus connector 3 now shares an interrupt with the onboard interrupt source.

Table 20. PCI Interrupt Routing Map

| PCI Interrupt Source | ICH4 PIRQ Signal Name | | | | | | | |
|-----------------------------------|-----------------------|-------|-------|-------|-------|-------|-------|-------|
| | PIRQA | PIRQB | PIRQC | PIRQD | PIRQE | PIRQF | PIRQG | PIRQH |
| Intel Extreme Graphics Controller | INTA | | | | | | | |
| ICH4 USB UHCI controller 1 | INTA | | | | | | | |
| SMBus controller | | INTB | | | | | | |
| ICH4 USB UHCI controller 2 | | | | INTB | | | | |
| AC '97 ICH4 Audio/Modem | | INTB | | | | | | |
| ICH4 LAN | | | | | INTA | | | |
| ICH4 USB UHCI controller 3 | | | INTC | | | | | |
| ICH4 USB 2.0 EHCI controller | | | | | | | | INTD |
| PCI bus connector 1 | | | | | INTD | INTA | INTB | INTC |
| PCI bus connector 2 | | | | | INTC | INTB | INTA | INTD |
| PCI bus connector 3 | INTD | INTC | INTA | INTB | | | | |

 **NOTE**

In PIC mode, the ICH4 can connect each PIRQ line internally to one of the IRQ signals (3, 4, 5, 6, 7, 9, 10, 11, 12, 14, and 15). Typically, a device that does not share a PIRQ line will have a unique interrupt. However, in certain interrupt-constrained situations, it is possible for two or more of the PIRQ lines to be connected to the same IRQ signal. Refer to Table 19 for the allocation of PIRQ lines to IRQ signals in APIC mode.

2.8 Connectors



CAUTION

Only the back panel USB, front panel USB, VGA, and PS/2 connectors have overcurrent protection. The Desktop Boards' internal connectors are not overcurrent protected and should connect only to devices inside the computer's chassis, such as fans and internal peripherals. Do not use these connectors to power devices external to the computer's chassis. A fault in the load presented by the external devices could cause damage to the computer, the interconnecting cable, and the external devices themselves.

This section describes the board's connectors. The connectors can be divided into these groups:

- Back panel I/O connectors (see page 48)
 - PS/2 keyboard and mouse
 - USB (four ports)
 - Parallel port
 - Serial port A
 - VGA port
 - LAN (optional)
 - Audio (line out, line in, and mic in)
- Internal I/O connectors (see page 49)
 - Audio (auxiliary line input, ATAPI CD-ROM, and front panel audio)
 - Fans
 - Power
 - Add-in boards (PCI)
 - IDE
 - Diskette drive
 - Chassis intrusion
- External I/O connectors (see page 54)
 - Serial Port B (optional)
 - Auxiliary front panel power/sleep/message-waiting LED
 - Front panel (power/sleep/message-waiting LED, power switch, hard drive activity LED, reset switch, and auxiliary front panel power LED)
 - Front panel USB (one connector for two ports)



NOTE

When installing the board in a microATX chassis, make sure that peripheral devices are installed at least 1.5 inches above the main power connector, the diskette drive connector, the IDE connector, and the DIMM sockets.

2.8.1 Back Panel Connectors

Figure 4 shows the location of the back panel connectors. The back panel connectors are color-coded in compliance with PC 99 recommendations. The figure legend below lists the colors used.

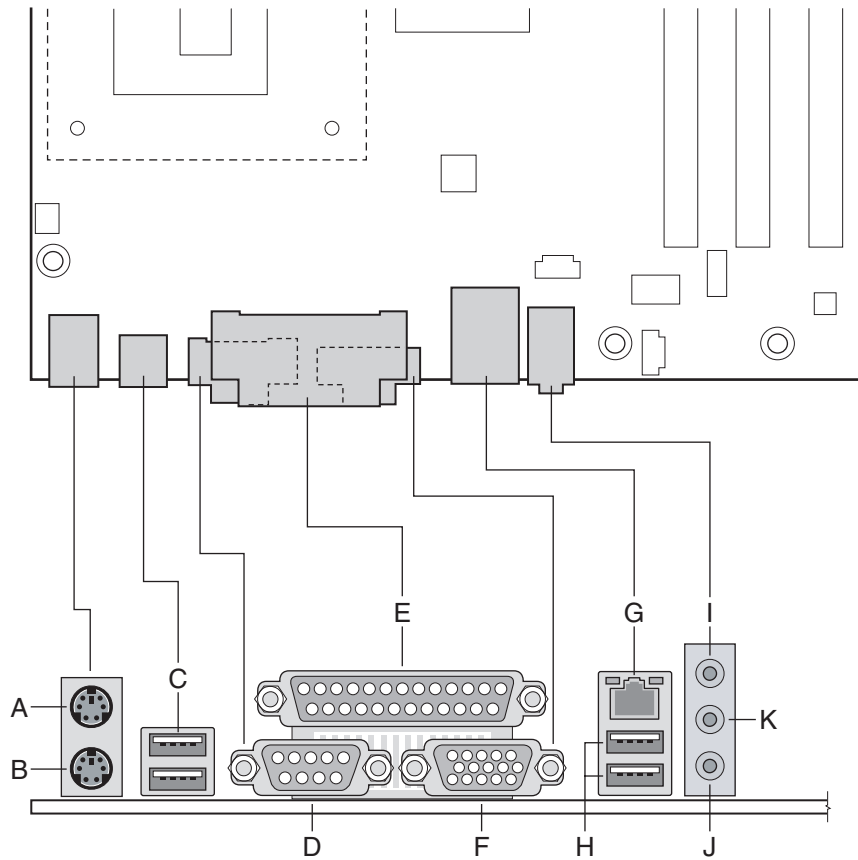

OM16235

| Item | Description | Color |
|------|--------------------|------------|
| A | PS/2 mouse port | Green |
| B | PS/2 keyboard port | Purple |
| C | USB ports | Black |
| D | Serial port A | Teal |
| E | Parallel port | Burgundy |
| F | VGA | Dark blue |
| G | LAN (optional) | Black |
| H | USB ports | Black |
| I | Audio line in | Light blue |
| J | Mic in | Pink |
| K | Audio line out | Lime green |

Figure 4. Back Panel Connectors

INTEGRATOR'S NOTE

The back panel audio line out connector is designed to power headphones or amplified speakers only. Poor audio quality occurs if passive (non-amplified) speakers are connected to this output.

2.8.2 Internal I/O Connectors

The internal I/O connectors are divided into the following functional groups:

- Audio, power, and hardware control (see page 50)
 - Front panel audio
 - Auxiliary line in
 - ATAPI CD-ROM
 - Fans (3)
 - ATX12V power
 - Main power
 - Chassis intrusion
- Add-in boards and peripheral interfaces (see page 53)
 - PCI bus
 - IDE
 - Diskette drive

2.8.2.1 Expansion Slots

The Desktop Board has three PCI rev 2.2 compliant local bus slots. The SMBus is routed to PCI bus connector 2.

INTEGRATOR'S NOTE

This document references back-panel slot numbering with respect to processor location on the Desktop Board. PCI slots are identified as PCI slot #x, starting with the slot closest to the processor. The ATX/microATX specifications identify expansion slot locations with respect to the far edge of a full-sized ATX chassis. The ATX specification and the Desktop Board's silkscreen are opposite and could cause confusion. The ATX numbering convention is made without respect to slot type, but refers to an actual slot location on a chassis. Figure 6 on page 53 illustrates the Desktop Board's PCI slot numbering.

2.8.2.2 Audio, Power, and Hardware Control Connectors

Figure 5 shows the location of the audio, power, and hardware control connectors.

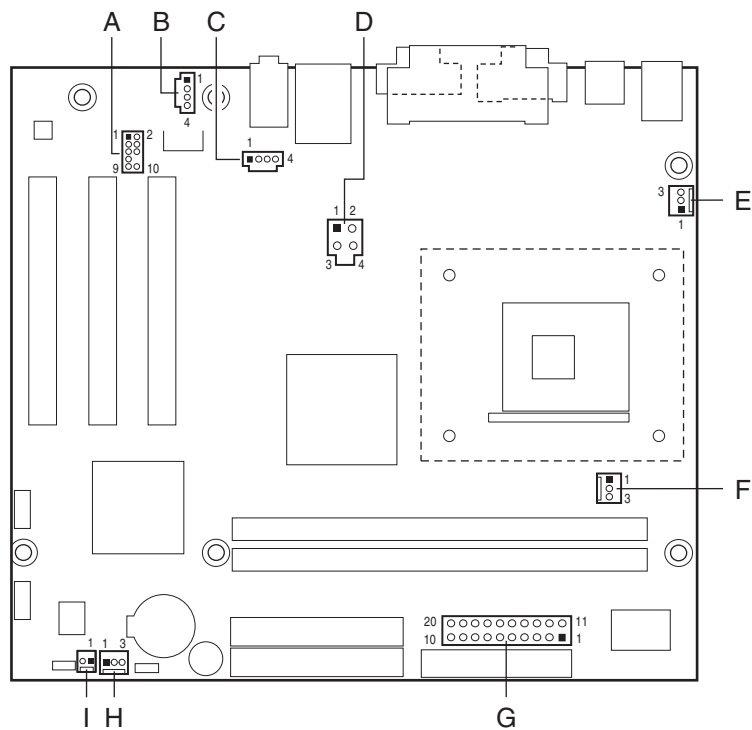

OM16236

| Item | Description | For more information see: |
|------|---------------------------------------|---------------------------|
| A | Front panel audio | Table 21 |
| B | Auxiliary line in, ATAPI style (gray) | Table 22 |
| C | ATAPI CD-ROM (black) | Table 23 |
| D | +12 V power connector (ATX12V) | Table 24 |
| E | Rear chassis fan | Table 25 |
| F | Processor fan | Table 26 |
| G | Main power | Table 27 |
| H | Front chassis fan | Table 28 |
| I | Chassis intrusion | Table 29 |

Figure 5. Audio, Power, and Hardware Control Connectors

Table 21. Front Panel Audio Connector

| Pin | Signal Name | Pin | Signal Name |
|-----|-------------|-----|-------------|
| 1 | MIC_IN | 2 | Ground |
| 3 | MIC_BIAS | 4 | +5 V |
| 5 | RIGHT_OUT | 6 | RIGHT_IN |
| 7 | No connect | 8 | Key |
| 9 | LEFT_OUT | 10 | LEFT_IN |

Table 22. Auxiliary Line In Connector

| Pin | Signal Name |
|-----|-------------------------|
| 1 | Left auxiliary line in |
| 2 | Ground |
| 3 | Ground |
| 4 | Right auxiliary line in |

Table 23. ATAPI CD-ROM Connector

| Pin | Signal Name |
|-----|-------------------------------|
| 1 | Left audio input from CD-ROM |
| 2 | CD audio differential ground |
| 3 | CD audio differential ground |
| 4 | Right audio input from CD-ROM |

INTEGRATOR'S NOTES

- *Use only ATX12V-, SFX12V-, or TFX12V-compliant power supplies with this board. ATX12V, SFX12V, and TFX12V power supplies have an additional power lead that provides required supplemental power for the processor. Always connect the 20-pin and 4-pin leads of ATX12V, SFX12V, and TFX12V power supplies to the corresponding connectors on the Desktop Board, otherwise the Desktop Board will not boot.*
- *Do not use a standard ATX power supply. The Desktop Board will not boot with a standard ATX power supply.*

Table 24. ATX12V Power Connector

| Pin | Signal Name | Pin | Signal Name |
|-----|-------------|-----|-------------|
| 1 | Ground | 2 | Ground |
| 3 | +12 V | 4 | +12 V |

Table 25. Rear Chassis Fan Connector

| Pin | Signal Name |
|-----|--|
| 1 | Ground (default) or FNT_REAR_FAN_CTRL (optional) |
| 2 | +12 V |
| 3 | No connect (default) or REAR_TACH_OUT (optional) |

Table 26. Processor Fan Connector

| Pin | Signal Name |
|-----|---|
| 1 | Ground (default) or CPU_FAN_CTRL (optional) |
| 2 | +12 V |
| 3 | No connect (default) or CPU_FAN_TACH |

Table 27. Main Power Connector

| Pin | Signal Name | Pin | Signal Name |
|-----|--------------------|-----|-------------------------------------|
| 1 | +3.3 V | 11 | +3.3 V |
| 2 | +3.3 V | 12 | -12 V |
| 3 | Ground | 13 | Ground |
| 4 | +5 V | 14 | PS-ON# (power supply remote on/off) |
| 5 | Ground | 15 | Ground |
| 6 | +5 V | 16 | Ground |
| 7 | Ground | 17 | Ground |
| 8 | PWRGD (Power Good) | 18 | No connect |
| 9 | +5 V (Standby) | 19 | +5 V |
| 10 | +12 V | 20 | +5 V |

Table 28. Front Chassis Fan Connector

| Pin | Signal Name |
|-----|---|
| 1 | Ground (default) or FNT_REAR_FAN_CTRL (optional) |
| 2 | +12 V |
| 3 | No connect (default) or FRONT_FAN_TACH (optional) |

Table 29. Chassis Intrusion Connector

| Pin | Signal Name |
|-----|-------------|
| 1 | Intruder |
| 2 | Ground |

2.8.2.3 Add-in Board and Peripheral Interface Connectors

Figure 6 shows the location of the add-in board connector and peripheral connectors for the Desktop Board D845GVSR. Note the following considerations for the PCI bus connectors:

- All of the PCI bus connectors are bus master capable.
- SMBus signals are routed to PCI bus connector 2, enabling PCI bus add-in boards with SMBus support to access sensor data on the Desktop Board. The SMBus signals are as follows:
 - The SMBus clock line is connected to pin A40.
 - The SMBus data line is connected to pin A41.

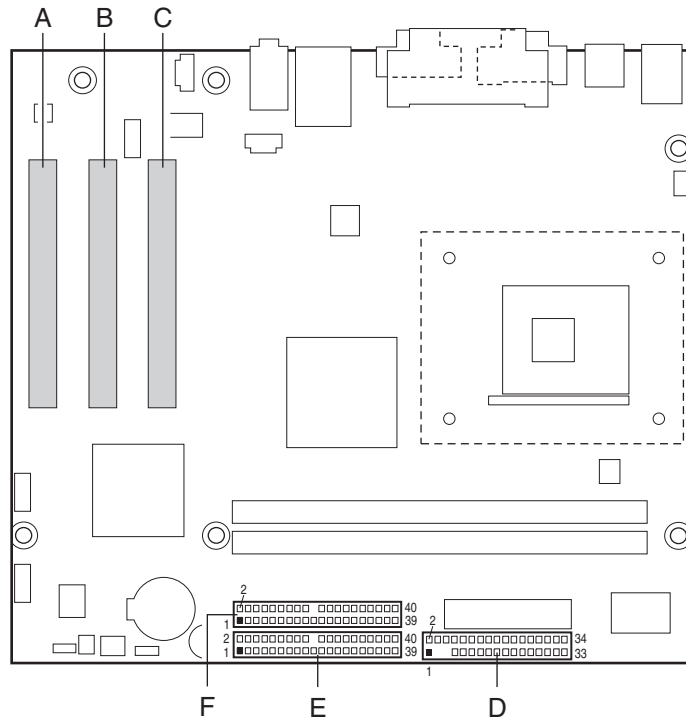

OM16237

| Item | Description |
|------|---------------------|
| A | PCI bus connector 3 |
| B | PCI bus connector 2 |
| C | PCI bus connector 1 |
| D | Diskette drive |
| E | Primary IDE |
| F | Secondary IDE |

Figure 6. Add-in Board and Peripheral Interface Connectors

2.8.3 External I/O Connectors

Figure 7 shows the locations of the external I/O connectors.

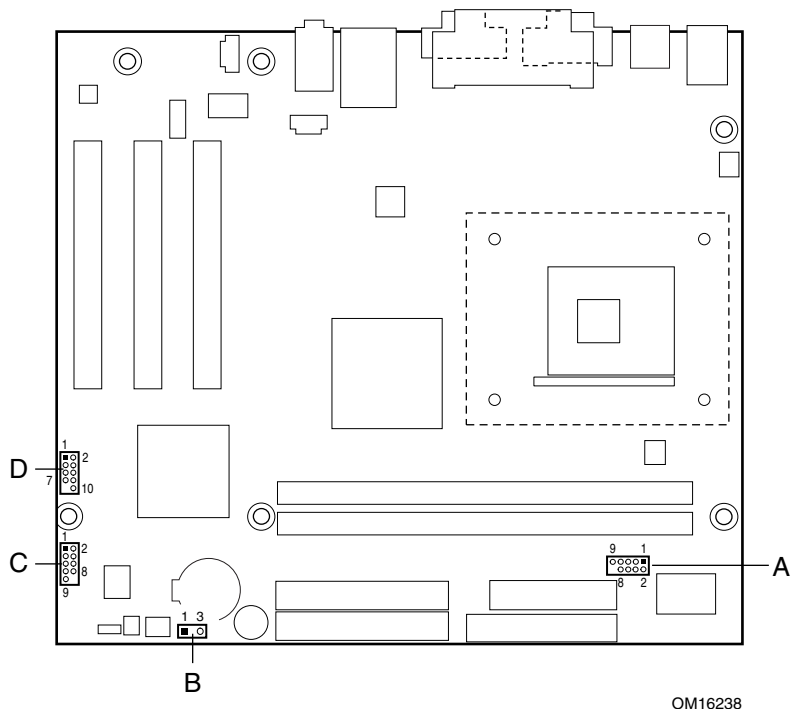

OM16238

| Item | Description | For more information see: |
|------|---|---------------------------|
| A | Serial Port B (optional) | Table 30 |
| B | Auxiliary front panel power/sleep/message-waiting LED | Table 31 |
| C | Front panel | Table 32 and Figure 8 |
| D | Front panel USB | Figure 9 |

Figure 7. External I/O Connectors

Table 30. Serial Port B Connector (optional)

| Pin | Signal Name | Pin | Signal Name |
|-----|-------------|-----|---------------|
| 1 | DCD | 2 | RXD |
| 3 | TXD | 4 | DTR |
| 5 | Ground | 6 | DSR |
| 7 | RTS | 8 | CTS |
| 9 | RI | 10 | Not connected |

2.8.3.1 Auxiliary Front Panel Power/Sleep/Message-Waiting LED Connector

Pins 1 and 3 of this connector duplicate the signals on pins 2 and 4 of the front panel connector. Table 31 lists the signal names of the Auxiliary Front Panel Power/Sleep/Message-Waiting LED Connector.

Table 31. Auxiliary Front Panel Power/Sleep/Message-Waiting LED Connector

| Pin | Signal Name | In/Out | Description |
|-----|---------------|--------|------------------------|
| 1 | HDR_BLNK_GRN | Out | Front panel green LED |
| 2 | Not connected | | |
| 3 | HDR_BLNK_YEL | Out | Front panel yellow LED |

2.8.3.2 Front Panel Connector

This section describes the functions of the front panel connector. Table 32 lists the signal names of the front panel connector. Figure 8 is a connection diagram for the front panel connector.

Table 32. Front Panel Connector

| Pin | Signal | In/Out | Description | Pin | Signal | In/Out | Description |
|--------------------------------|-----------|--------|---------------------------------------|----------------------|--------------|--------|------------------------|
| Hard Drive Activity LED | | | | Power LED | | | |
| 1 | HD_PWR | Out | Hard disk LED pull-up (750 Ω) to +5 V | 2 | HDR_BLNK_GRN | Out | Front panel green LED |
| 3 | HAD# | Out | Hard disk active LED | 4 | HDR_BLNK_YEL | Out | Front panel yellow LED |
| Reset Switch | | | | On/Off Switch | | | |
| 5 | Ground | | Ground | 6 | SWITCH_ON# | In | Power switch |
| 7 | FP_RESET# | In | Reset switch | 8 | Ground | | Ground |
| 9 | +5 V | Out | Power | 10 | No connect | | Not connected |

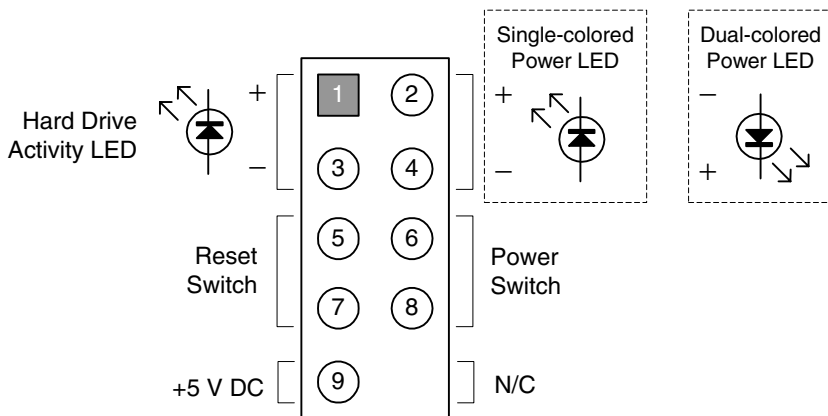

OM16110

Figure 8. Connection Diagram for Front Panel Connector

2.8.3.2.1 Hard Drive Activity LED Connector

Pins 1 and 3 can be connected to an LED to provide a visual indicator that data is being read from or written to a hard drive. For the LED to function properly, an IDE drive must be connected to the onboard IDE interface.

2.8.3.2.2 Reset Switch Connector

Pins 5 and 7 can be connected to a momentary SPST type switch that is normally open. When the switch is closed, the Desktop Board resets and runs the POST.

2.8.3.2.3 Power/Sleep/Message Waiting LED Connector

Pins 2 and 4 can be connected to a one- or two-color LED. Table 33 shows the possible states for a one-color LED. Table 34 shows the possible states for a two-color LED.

Table 33. States for a One-Color Power LED

| LED State | Description |
|----------------|-------------------------|
| Off | Power off/sleeping |
| Steady Green | Running |
| Blinking Green | Running/message waiting |

Table 34. States for a Two-Color Power LED

| LED State | Description |
|-----------------|--------------------------|
| Off | Power off |
| Steady Green | Running |
| Blinking Green | Running/message waiting |
| Steady Yellow | Sleeping |
| Blinking Yellow | Sleeping/message waiting |



INTEGRATOR'S NOTE

To use the message waiting function, ACPI must be enabled in the operating system and a message-capturing application must be invoked.

2.8.3.2.4 Power Switch Connector

Pins 6 and 8 can be connected to a front panel momentary-contact power switch. The switch must pull the SW_ON# pin to ground for at least 50 ms to signal the power supply to switch on or off. (The time requirement is due to internal debounce circuitry on the Desktop Board D845GVSR.) At least two seconds must pass before the power supply will recognize another on/off signal.

2.8.3.3 Front Panel USB Connector

Figure 9 is a connection diagram for the front panel USB connector.

INTEGRATOR'S NOTES

- *The +5 V DC power on the USB connector is fused.*
- *Pins 1, 3, 5, and 7 comprise one USB port.*
- *Pins 2, 4, 6, and 8 comprise one USB port.*
- *Use only a front panel USB connector that conforms to the USB 2.0 specification for high-speed USB devices.*

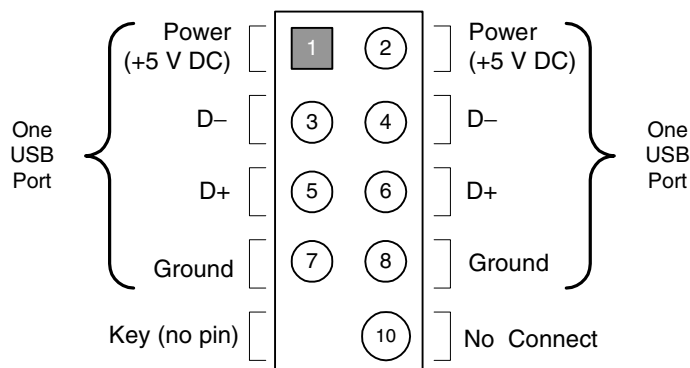

OM15963

Figure 9. Connection Diagram for Front Panel USB Connector

2.9 Jumper Blocks



CAUTION

Do not move any jumpers with the power on. Always turn off the power and unplug the power cord from the computer before changing a jumper setting. Otherwise, the Desktop Board could be damaged.

Figure 10 shows the location of the jumper blocks.

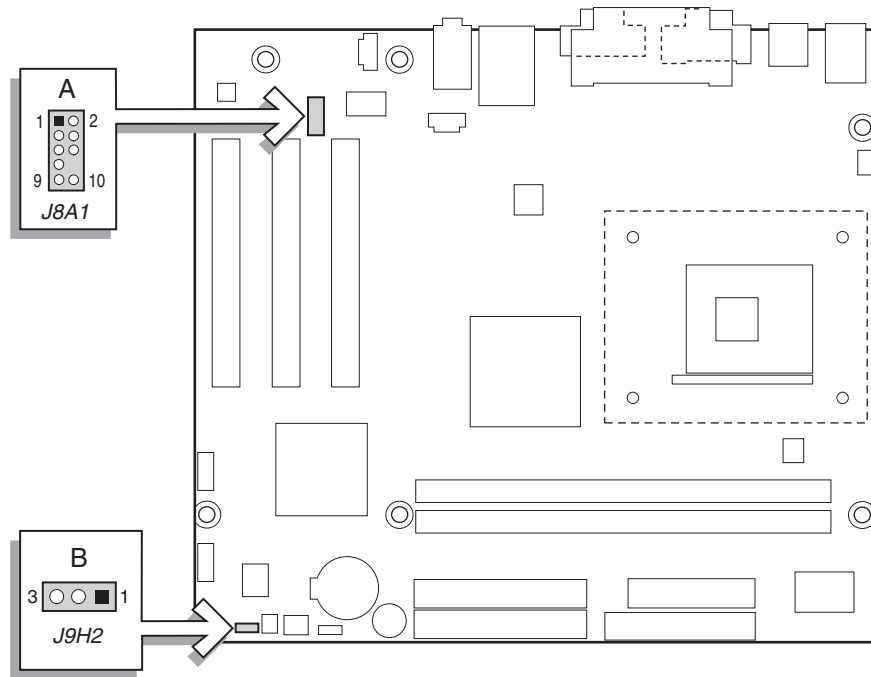

OM16239

| Item | Description | Reference Designator |
|------|--|----------------------|
| A | Front panel audio connector/jumper block | J8A1 |
| B | BIOS Setup configuration jumper block | J9H2 |

Figure 10. Location of the Jumper Blocks

2.9.1 Front Panel Audio Connector/Jumper Block

This connector has two functions:

- With jumpers installed, the audio line out signals are routed to the back panel audio line out connector.
- With jumpers removed, the connector provides audio line out and mic in signals for front panel audio connectors.

Table 35 describes the two configurations of this connector/jumper block.



CAUTION

Do not place jumpers on this block in any configuration other than the one described in Table 35. Other jumper configurations are not supported and could damage the Desktop Board.

Table 35. Front Panel Audio Connector/Jumper Block

| Jumper Setting | | Configuration |
|----------------|---|--|
| | <p>1 and 2</p> <p>5 and 6</p> <p>9 and 10</p> | <p>Audio line out signals are routed to the back panel audio line out connector. The back panel audio line out connector is shown in Figure 4 on page 48.</p> |
| | <p>No jumpers installed</p> | <p>Audio line out and mic in signals are available for front panel audio connectors. Table 21 on page 51 lists the names of the signals available on this connector when no jumpers are installed.</p> |



INTEGRATOR'S NOTE

When the jumpers are removed and this connector is used for front panel audio, the back panel audio line out and mic in connectors are disabled.

2.9.2 BIOS Setup Configuration Jumper Block

The 3-pin jumper block determines the BIOS Setup program's mode. Table 36 describes the jumper settings for the three modes: normal, configure, and recovery. When the jumper is set to configuration mode and the computer is powered-up, the BIOS compares the processor version and the microcode version in the BIOS and reports if the two match.

Table 36. BIOS Setup Configuration Jumper Settings

| Function/Mode | Jumper Setting | Configuration |
|---------------|----------------|---|
| Normal | 1-2 | The BIOS uses current configuration information and passwords for booting. |
| Configure | 2-3 | After the POST runs, Setup runs automatically. The maintenance menu is displayed. |
| Recovery | None | The BIOS attempts to recover the BIOS configuration. A recovery diskette is required. |

2.10 Mechanical Considerations

The Desktop Board D845GVSR is designed to fit into either a microATX or an ATX-form-factor chassis. Figure 11 illustrates the mechanical form factor for the Desktop Board. Dimensions are given in inches [millimeters]. The outer dimensions are 9.20 inches by 8.20 inches [233.68 millimeters by 208.28 millimeters]. Location of the I/O connectors and mounting holes are in compliance with the ATX specification.

INTEGRATOR'S NOTE

When installing the Desktop Board in a microATX chassis, make sure that peripheral devices are installed at least 1.5 inches above the main power connector, the diskette drive connector, the IDE connector, and the DIMM sockets.

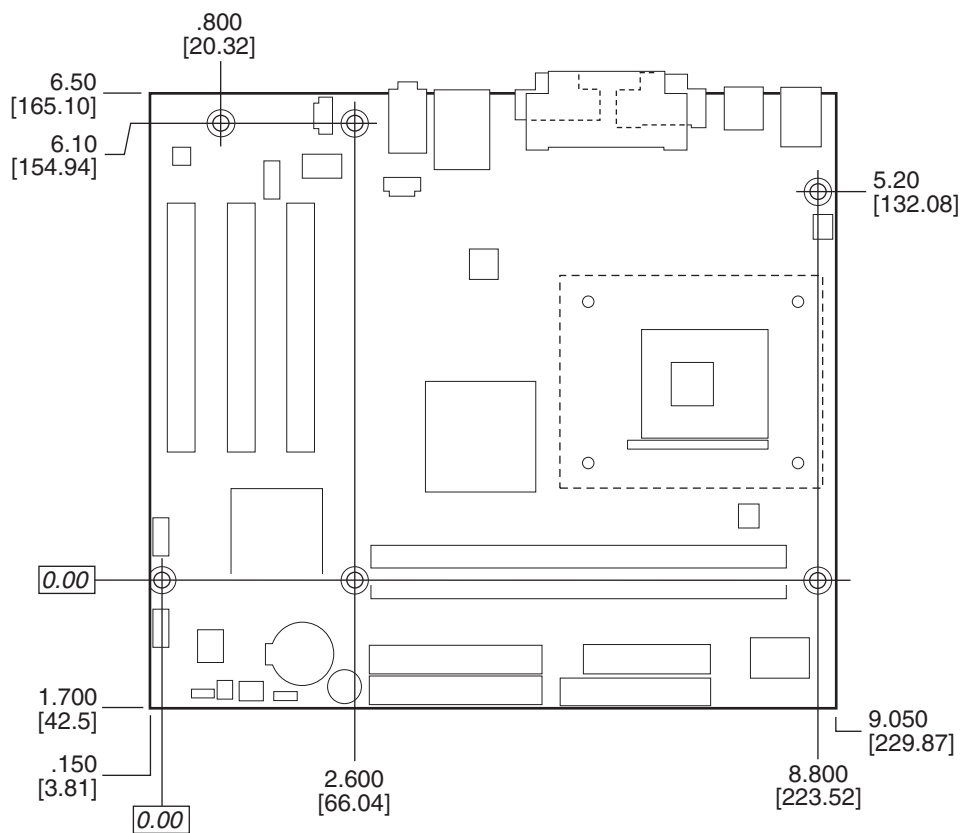

OM16240

Figure 11. Desktop Board Dimensions

2.10.1 I/O Shield

The back panel I/O shield for the Desktop Board D845GVSR must meet specific dimension and material requirements. Systems based on this Desktop Board need the back panel I/O shield to pass emissions (EMI) certification testing. Figure 12 shows the critical dimensions of the I/O shield. Dimensions are given in inches [millimeters], to a tolerance of ± 0.020 inches [0.508 millimeters].

The figures also indicate the position of each cutout. Additional design considerations for I/O shields relative to chassis requirements are described in the ATX specification. See Section 1.5 for information about the ATX specification.

INTEGRATOR'S NOTE

An I/O shield compliant with the ATX chassis specification 2.03 is available from Intel.

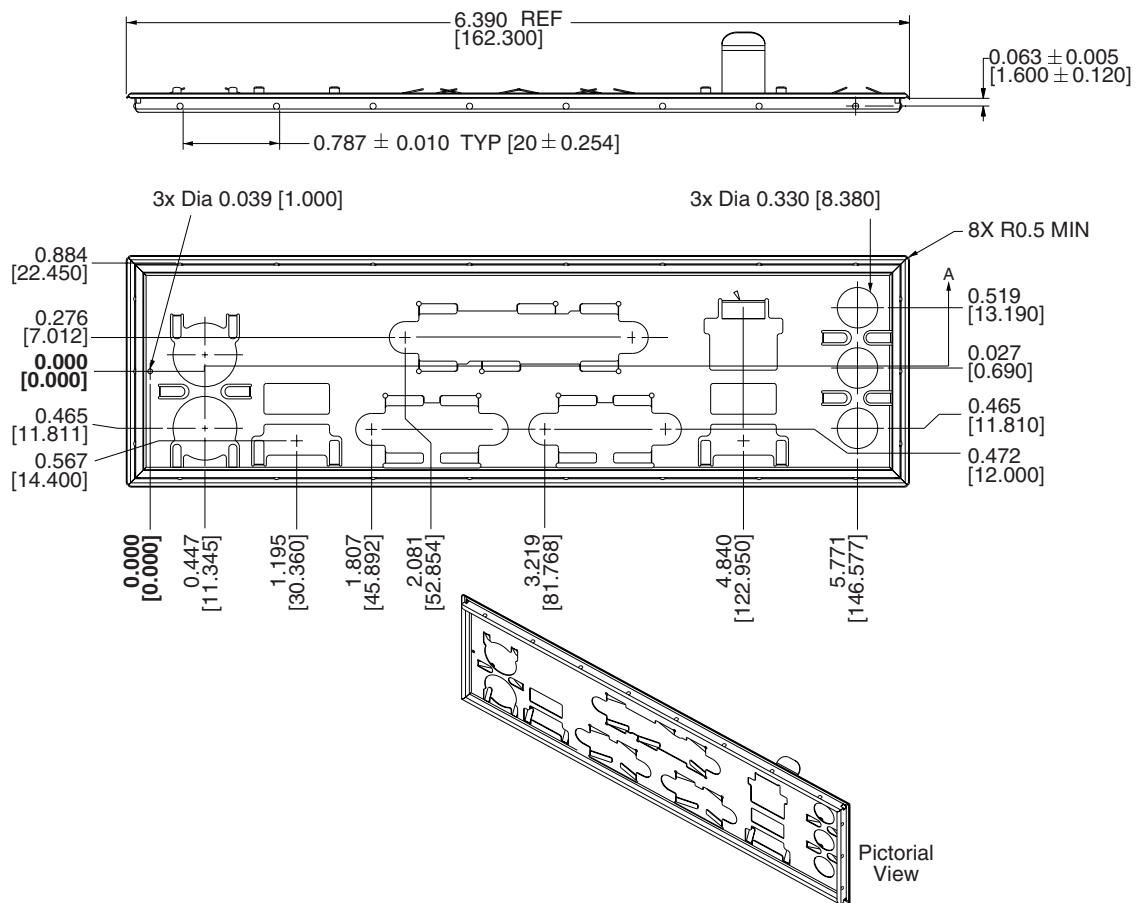

OM11487

Figure 12. I/O Shield Dimensions

2.11 Electrical Considerations

2.11.1 DC Loading

Table 37 lists the DC loading characteristics of the board. This data is based on a DC analysis of all active components within the board that impact its power delivery subsystems. The analysis does not include PCI add-in cards. Minimum values assume a light load placed on the board that is similar to an environment with no applications running and no USB current draw. Maximum values assume a load placed on the board that is similar to a heavy gaming environment with a 500 mA current draw per USB port. These calculations are not based on specific processor values or memory configurations but are based on the minimum and maximum current draw possible from the board's power delivery subsystems to the processor, memory, and USB ports.

Use the datasheets for add-in cards, such as PCI, to determine the overall system power requirements. The selection of a power supply at the system level is dependent on the system's usage model and not necessarily tied to a particular processor speed.

Table 37. DC Loading Characteristics

| Mode | DC Power | DC Current at: | | | | |
|-----------------|----------|----------------|---------|---------|--------|--------|
| | | +3.3 V | +5 V | +12 V | -12 V | +5 VSB |
| Minimum loading | 190.00 W | 5.00 A | 11.00 A | 9.00 A | 0.03 A | 0.60 A |
| Maximum loading | 286.00 W | 11.00 A | 15.00 A | 13.00 A | 0.10 A | 1.40 A |

2.11.2 Add-in Board Considerations

The Desktop Board D845GVSR is designed to provide 2 A (average) of +5 V current for each add-in board. The total +5 V current draw for add-in boards for a fully loaded Desktop Board D845GVSR (all three expansion slots filled) must not exceed 6 A.

2.11.3 Fan Connector Current Capability



CAUTION

The processor fan must be connected to the processor fan connector, not to a chassis fan connector. Connecting the processor fan to a chassis fan connector may result in onboard component damage that will halt fan operation.

Table 38 lists the current capability of the fan connectors on the Desktop Board D845GVSR.

Table 38. Fan Connector Current Capability

| Fan Connector | Maximum Available Current |
|-------------------|---------------------------|
| Processor fan | 1.00 A |
| Front chassis fan | 1.00 A |
| Rear chassis fan | 1.00 A |

2.11.4 Power Supply Considerations



CAUTION

The +5 V standby line for the power supply must be capable of providing adequate +5 V standby current. Failure to do so can damage the power supply. The total amount of standby current required depends on the wake devices supported and manufacturing options.

System integrators should refer to the power usage values listed in Table 37 when selecting a power supply for use with the Desktop Board D845GVSR.

Additional power required will depend on configurations chosen by the integrator.

The power supply must comply with the following recommendations found in the indicated sections of the ATX form factor specification.

- The potential relation between 3.3 VDC and +5 VDC power rails (Section 4.2)
- The current capability of the +5 VSB line (Section 4.2.1.2)
- All timing parameters (Section 4.2.1.3)
- All voltage tolerances (Section 4.2.2)

For information about

The ATX form factor specification

Refer to

Section 1.5, page 17

2.12 Thermal Considerations



CAUTION

The use of an Intel Pentium 4 processor operating above 2.80 GHz with this Intel desktop board requires the following:

- *A chassis with appropriate airflow to ensure proper cooling of the components on the board*
- *A processor fan heatsink that meets the thermal performance targets for Pentium 4 processors operating above 2.80 GHz*

Failure to ensure appropriate airflow may result in reduced performance of both the processor and/or voltage regulator or, in some instances, damage to the desktop board. For a list of chassis that have been tested with Intel desktop boards please refer to the following website:

<http://developer.intel.com/design/motherbd/cooling.htm>

All responsibility for determining the adequacy of any thermal or system design remains solely with the reader. Intel makes no warranties or representations that merely following the instructions presented in this document will result in a system with adequate thermal performance.



CAUTION

Ensure that the ambient temperature does not exceed the Desktop Board's maximum operating temperature. Failure to do so could cause components to exceed their maximum case temperature and malfunction. For information about the maximum operating temperature, see the environmental specifications in Section 2.14.



CAUTION

Ensure that proper airflow is maintained in the processor voltage regulator circuit. Failure to do so may result in damage to the voltage regulator circuit. The processor voltage regulator area (item A in Figure 13) can reach a temperature of up to 85 °C in an open chassis.

Figure 13 shows the locations of the localized high temperature zones.

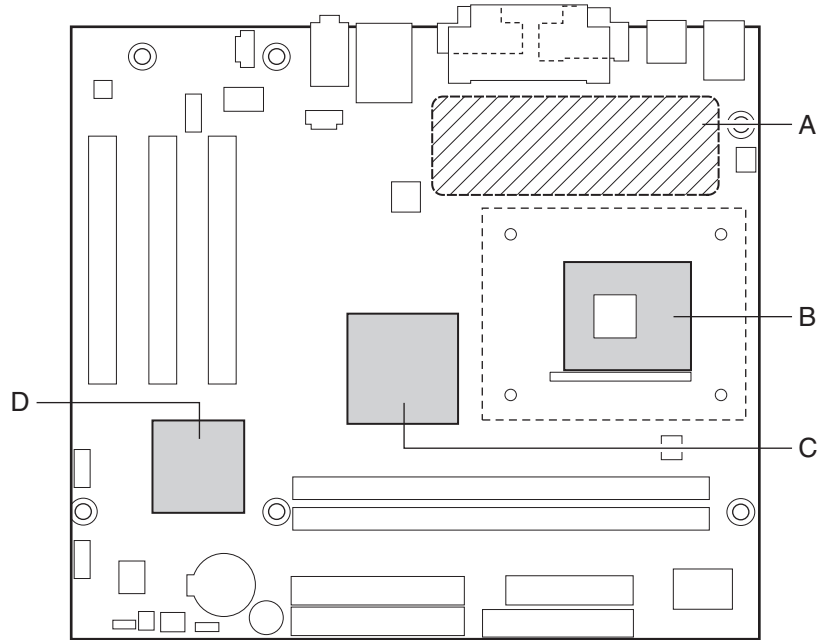

| Item | Description |
|------|----------------------------------|
| A | Processor voltage regulator area |
| B | Processor |
| C | Intel 82845GV GMCH |
| D | Intel 82801DB ICH4 |

Figure 13. Localized High Temperature Zones

Table 39 provides maximum case temperatures for Desktop Board D845GVSR components that are sensitive to thermal changes. The operating temperature, current load, or operating frequency could affect case temperatures. Maximum case temperatures are important when considering proper airflow to cool the Desktop Board D845GVSR.

Table 39. Thermal Considerations for Components

| Component | Maximum Case Temperature |
|---------------------------|--|
| Intel Pentium 4 processor | For processor case temperature, see processor datasheets and processor specification updates |
| Intel 82845GV GMCH | 92 °C (under bias) |
| Intel 82801DB ICH4 | 110 °C (under bias) |

2.13 Reliability

The Mean Time Between Failures (MTBF) prediction is calculated using component and subassembly random failure rates. The calculation is based on the Bellcore Reliability Prediction Procedure, TR-NWT-000332, Issue 4, September 1991. The MTBF prediction is used to estimate repair rates and spare parts requirements.

The MTBF data is calculated from predicted data at 55 °C. The Desktop Board D845GVSR MTBF is 149979.68 hours.

2.14 Environmental

Table 40 lists the environmental specifications for the Desktop Board D845GVSR.

Table 40. Desktop Board D845GVSR Environmental Specifications

| Parameter | Specification | | |
|--------------------|--|--------------------|------------------------------|
| Temperature | | | |
| Non-Operating | -40 °C to +70 °C | | |
| Operating | 0 °C to +55 °C | | |
| Shock | | | |
| Unpackaged | 50 g trapezoidal waveform Velocity change of 170 inches/second | | |
| Packaged | Half sine 2 millisecond | | |
| | Product Weight (pounds) | Free Fall (inches) | Velocity Change (inches/sec) |
| | <20 | 36 | 167 |
| | 21-40 | 30 | 152 |
| | 41-80 | 24 | 136 |
| | 81-100 | 18 | 118 |
| Vibration | | | |
| Unpackaged | 5 Hz to 20 Hz: 0.01 g ² Hz sloping up to 0.02 g ² Hz 20 Hz to 500 Hz: 0.02 g ² Hz (flat) | | |
| Packaged | 10 Hz to 40 Hz: 0.015 g ² Hz (flat) 40 Hz to 500 Hz: 0.015 g ² Hz sloping down to 0.00015 g ² Hz | | |

2.15 Regulatory Compliance

This section describes the Desktop Boards' compliance with U.S. and international safety and electromagnetic compatibility (EMC) regulations.

2.15.1 Safety Regulations

Table 41 lists the safety regulations the Desktop Board D845GVSR complies with when correctly installed in a compatible host system.

Table 41. Safety Regulations

| Regulation | Title |
|---|---|
| UL 60950 3rd ed., 2000/CSA C22.2 No. 60950-00 | Bi-National Standard for Safety of Information Technology Equipment including Electrical Business Equipment. (USA and Canada) |
| EN 60950:2000 | The Standard for Safety of Information Technology Equipment including Electrical Business Equipment. (European Union) |
| IEC 60950, 3 rd Edition, 1999 | The Standard for Safety of Information Technology Equipment including Electrical Business Equipment. (International) |

2.15.2 EMC Regulations

Table 42 lists the EMC regulations the Desktop Board D845GVSR complies with when correctly installed in a compatible host system.

Table 42. EMC Regulations

| Regulation | Title |
|---|---|
| FCC (Class B) | Title 47 of the Code of Federal Regulations, Parts 2 and 15, Subpart B, Radio Frequency Devices. (USA) |
| ICES-003 (Class B) | Interference-Causing Equipment Standard, Digital Apparatus. (Canada) |
| EN55022: 1998 (Class B) | Limits and methods of measurement of Radio Interference Characteristics of Information Technology Equipment. (European Union) |
| EN55024: 1998 | Information Technology Equipment – Immunity Characteristics Limits and methods of measurement. (European Union) |
| AS/NZS 3548 (Class B) | Australian Communications Authority, Standard for Electromagnetic Compatibility. (Australia and New Zealand) |
| CISPR 22, 3 rd Edition (Class B) | Limits and methods of measurement of Radio Disturbance Characteristics of Information Technology Equipment. (International) |
| CISPR 24: 1997 | Information Technology Equipment – Immunity Characteristics – Limits and Methods of Measurements. (International) |

2.15.2.1 FCC Compliance Statement (USA)

Product Type: D845GVSR Desktop Board

This device complies with Part 15 of the FCC Rules. Operation is subject to the following two conditions: (1) This device may not cause harmful interference, and (2) this device must accept any interference received, including interference that may cause undesired operation.

This equipment has been tested and found to comply with the limits for a Class B digital device, pursuant to Part 15 of the FCC Rules. These limits are designed to provide reasonable protection against harmful interference in a residential environment. This equipment generates, uses, and can radiate radio frequency energy and, if not installed and used in accordance with the instructions, may cause harmful interference to radio communications. However, there is no guarantee that interference will not occur in a particular installation. If this equipment does cause harmful interference to radio or television reception, which can be determined by turning the equipment off and on, the user is encouraged to try to correct the interference by one or more of the following measures:

- Reorient or relocate the receiving antenna.
- Increase the separation between the equipment and the receiver.
- Connect the equipment to a different electrical branch circuit from that to which the receiver is connected.
- Consult the dealer or an experienced radio/TV technician for help.

Any changes or modifications to the equipment not expressly approved by Intel Corporation could void the user's authority to operate the equipment.

2.15.2.2 Canadian Compliance Statement

This Class B digital apparatus complies with Canadian ICES-003.

Cet appareil numérique de la classe B est conforme à la norme NMB-003 du Canada.

2.15.3 European Union Declaration of Conformity Statement

We, Intel Corporation, declare under our sole responsibility that the product: Intel® Desktop Board D845GVSR is in conformity with all applicable essential requirements necessary for CE marking, following the provisions of the European Council Directive 89/336/EEC (EMC Directive) and Council Directive 73/23/EEC (Safety/Low Voltage Directive).

The product is properly CE marked demonstrating this conformity and is for distribution within all member states of the EU with no restrictions.



This product follows the provisions of the European Directives 89/336/EEC and 73/23/EEC.

2.15.4 Product Ecology Statements

The following information is provided to address worldwide product ecology concerns and regulations.

2.15.4.1 Disposal Considerations

This product contains the following materials that may be regulated upon disposal: lead solder on the printed wiring board assembly.

2.15.4.2 Recycling Considerations

Intel encourages its customers to recycle its products and their components (e.g., batteries, circuit boards, plastic enclosures, etc.) whenever possible. In the U.S., a list of recyclers in your area can be found at:







<http://www.eiae.org>

In the absence of a viable recycling option, products and their components must be disposed of in accordance with all applicable local environmental regulations.

2.15.5 Product Certification Markings (Board Level)

Table 43 lists the board’s product certification markings.

Table 43. Product Certification Markings

| Description | Marking | | | | | | |
|--|--|------------|--------------|---|--|------------------------|--|
| UL joint US/Canada Recognized Component mark. Includes adjacent UL file number for Intel Desktop Boards: E210882 (component side). |  | | | | | | |
| FCC Declaration of Conformity logo mark for Class B equipment; includes Intel name and D845GVSR model designation (component side). | <table border="1" data-bbox="1068 961 1333 1092"> <tr> <td data-bbox="1079 972 1161 993">Trade Name</td> <td data-bbox="1203 972 1325 993">Model Number</td> </tr> <tr> <td colspan="2" data-bbox="1079 1003 1325 1056">  Tested To Comply With FCC Standards </td> </tr> <tr> <td colspan="2" data-bbox="1096 1066 1308 1087">FOR HOME OR OFFICE USE</td> </tr> </table> | Trade Name | Model Number |  Tested To Comply With FCC Standards | | FOR HOME OR OFFICE USE | |
| Trade Name | Model Number | | | | | | |
|  Tested To Comply With FCC Standards | | | | | | | |
| FOR HOME OR OFFICE USE | | | | | | | |
| CE mark. Declares compliance to European Union (EU) EMC directive (89/336/EEC) and Low Voltage directive (73/23/EEC) (component side). The CE mark should also be on the shipping container. |  | | | | | | |
| Australian Communications Authority (ACA) C-Tick mark. Includes adjacent Intel supplier code number, N-232. The C-tick mark should also be on the shipping container. |  | | | | | | |
| Printed wiring board manufacturer’s recognition mark: consists of a unique UL recognized manufacturer’s logo, along with a flammability rating (solder side). | 94V-0 | | | | | | |

3 Overview of BIOS Features

What This Chapter Contains

- 3.1 Introduction.....69
- 3.2 BIOS Flash Memory Organization70
- 3.3 Resource Configuration70
- 3.4 System Management BIOS (SMBIOS)71
- 3.5 Legacy USB Support71
- 3.6 BIOS Updates72
- 3.7 Recovering BIOS Data73
- 3.8 Boot Options.....74
- 3.9 Fast Booting Systems with Intel® Rapid BIOS Boot.....75
- 3.10 BIOS Security Features.....76

3.1 Introduction

The Desktop Board D845GVSR uses an Intel/AMI BIOS that is stored in the Firmware Hub (FWH) and can be updated using a disk-based program. The FWH contains the BIOS Setup program, POST, the PCI auto-configuration utility, and Plug and Play support.

The BIOS displays a message during POST identifying the type of BIOS and a revision code. The initial production BIOSs are identified as VA84510A.86A.

When the Desktop Board’s jumper is set to configuration mode and the computer is powered-up, the BIOS compares the CPU version and the microcode version in the BIOS and reports if the two match.

| For information about | Refer to |
|---|----------------------|
| The Desktop Boards’ compliance level with Plug and Play | Section 1.5, page 17 |

3.2 BIOS Flash Memory Organization

The Firmware Hub (FWH) includes a 4 Mbit (512 KB) symmetrical flash memory device. Internally, the device is grouped into eight 64-KB blocks that are individually erasable, lockable, and unlockable.

3.3 Resource Configuration

3.3.1 PCI Autoconfiguration

The BIOS can automatically configure PCI devices. PCI devices may be onboard or add-in cards. Autoconfiguration lets a user insert or remove PCI cards without having to configure the system. When a user turns on the system after adding a PCI card, the BIOS automatically configures interrupts, the I/O space, and other system resources. Any interrupts set to Available in Setup are considered to be available for use by the add-in card.

For information about the versions of PCI and Plug and Play supported by the BIOS, see Section 1.5.

3.3.2 PCI IDE Support

If you select Auto in the BIOS Setup program, the BIOS automatically sets up the two PCI IDE connectors with independent I/O channel support. The IDE interface supports hard drives up to ATA-66/100 and recognizes any ATAPI compliant devices, including CD-ROM drives, tape drives, and Ultra DMA drives (see Section 1.5 for the supported version of ATAPI). The BIOS determines the capabilities of each drive and configures them to optimize capacity and performance. To take advantage of the high capacities typically available today, hard drives are automatically configured for Logical Block Addressing (LBA) and to PIO Mode 3 or 4, depending on the capability of the drive. You can override the auto-configuration options by specifying manual configuration in the BIOS Setup program.

To use ATA-66/100 features the following items are required:

- An ATA-66/100 peripheral device
- An ATA-66/100 compatible cable
- ATA-66/100 operating system device drivers

NOTE

ATA-66/100 compatible cables are backward compatible with drives using slower IDE transfer protocols. If an ATA-66/100 disk drive and a disk drive using any other IDE transfer protocol are attached to the same cable, the maximum transfer rate between the drives is reduced to that of the slowest device.

NOTE

Do not connect an ATA device as a slave on the same IDE cable as an ATAPI master device. For example, do not connect an ATA hard drive as a slave to an ATAPI CD-ROM drive.

3.4 System Management BIOS (SMBIOS)

SMBIOS is a Desktop Management Interface (DMI) compliant method for managing computers in a managed network.

The main component of SMBIOS is the Management Information Format (MIF) database, which contains information about the computing system and its components. Using SMBIOS, a system administrator can obtain the system types, capabilities, operational status, and installation dates for system components. The MIF database defines the data and provides the method for accessing this information. The BIOS enables applications such as third-party management software to use SMBIOS. The BIOS stores and reports the following SMBIOS information:

- BIOS data, such as the BIOS revision level
- Fixed-system data, such as peripherals, serial numbers, and asset tags
- Resource data, such as memory size, cache size, and processor speed
- Dynamic data, such as event detection and error logging

Non-Plug and Play operating systems, such as Windows NT[†], require an additional interface for obtaining the SMBIOS information. The BIOS supports an SMBIOS table interface for such operating systems. Using this support, an SMBIOS service-level application running on a non-Plug and Play operating system can obtain the SMBIOS information.

| For information about | Refer to |
|--|----------------------|
| The Desktop Boards' compliance level with SMBIOS | Section 1.5, page 17 |

3.5 Legacy USB Support

Legacy USB support enables USB devices such as keyboards, mice, and hubs to be used even when the operating system's USB drivers are not yet available. Legacy USB support is used to access the BIOS Setup program, and to install an operating system that supports USB. By default, Legacy USB support is set to Enabled.

Legacy USB support operates as follows:

1. When you apply power to the computer, legacy support is disabled.
2. POST begins.
3. Legacy USB support is enabled by the BIOS allowing you to use a USB keyboard to enter and configure the BIOS Setup program and the maintenance menu.
4. POST completes.
5. The operating system loads. While the operating system is loading, USB keyboards and mice are recognized and may be used to configure the operating system. (Keyboards and mice are not recognized during this period if Legacy USB support was set to Disabled in the BIOS Setup program.)

6. After the operating system loads the USB drivers, all legacy and non-legacy USB devices are recognized by the operating system, and Legacy USB support from the BIOS is no longer used.

To install an operating system that supports USB, verify that Legacy USB support in the BIOS Setup program is set to Enabled and follow the operating system's installation instructions.

 **NOTE**

Legacy USB support is for keyboards, mice, and hubs only. Other USB devices are not supported in legacy mode.

3.6 BIOS Updates

The BIOS can be updated using either of the following utilities, which are available on the Intel World Wide Web site:

- Intel® Express BIOS Update utility, which enables automated updating while in the Windows environment. Using this utility, the BIOS can be updated from a file on a hard disk, a 1.44 MB diskette, or a CD-ROM, or from the file location on the Web.
- Intel® Flash Memory Update Utility, which requires creation of a boot diskette and manual rebooting of the system. Using this utility, the BIOS can be updated from a file on a 1.44 MB diskette (from a legacy diskette drive or an LS-120 diskette drive) or a CD-ROM.

Both utilities support the following BIOS maintenance functions:

- Verifying that the updated BIOS matches the target system to prevent accidentally installing an incompatible BIOS.
- Updating both the BIOS boot block and the main BIOS. This process is fault tolerant to prevent boot block corruption.
- Updating the BIOS boot block separately.
- Changing the language section of the BIOS.
- Updating replaceable BIOS modules, such as the video BIOS module.
- Inserting a custom splash screen.

 **NOTE**

Review the instructions distributed with the upgrade utility before attempting a BIOS update.

| For information about | Refer to |
|-------------------------------|----------------------|
| The Intel World Wide Web site | Section 1.3, page 16 |

3.6.1 Language Support

The BIOS Setup program and help messages are supported in five languages: US English, German, Italian, French, and Spanish. The default language is US English, which is present unless another language is selected in the BIOS Setup program.

3.6.2 Custom Splash Screen

During POST, an Intel splash screen is displayed by default. This splash screen can be replaced with a custom splash screen. A utility is available from Intel to assist with creating a custom splash screen. The custom splash screen can be programmed into the flash memory using the BIOS upgrade utility. Information about this capability is available on the Intel Support World Wide Web site.

| For information about | Refer to |
|-------------------------------|----------------------|
| The Intel World Wide Web site | Section 1.3, page 16 |

3.7 Recovering BIOS Data

Some types of failure can destroy the BIOS. For example, the data can be lost if a power outage occurs while the BIOS is being updated in flash memory. The BIOS can be recovered from a diskette using the BIOS recovery mode. When recovering the BIOS, be aware of the following:

- Because of the small amount of code available in the non-erasable boot block area, there is no video support. You can only monitor this procedure by listening to the speaker or looking at the diskette drive LED.
- The recovery process may take several minutes; larger BIOS flash memory devices require more time.
- Two beeps and the end of activity in the diskette drive indicate successful BIOS recovery.
- A series of continuous beeps indicates a failed BIOS recovery.

To create a BIOS recovery diskette, a bootable diskette must be created and the BIOS update files copied to it. BIOS upgrades and the Intel Flash Memory Update Utility are available from Intel Customer Support through the Intel World Wide Web site.

NOTE

Even if the computer is configured to boot from an LS-120 diskette (in the Setup program's Removable Devices submenu), the BIOS recovery diskette must be a standard 1.44 MB diskette not a 120 MB diskette.

| For information about | Refer to |
|---|------------------------|
| The BIOS recovery mode jumper settings | Section 2.9.2, page 59 |
| The Boot menu in the BIOS Setup program | Section 4.7, page 96 |
| Contacting Intel customer support | Section 1.3, page 16 |

3.8 Boot Options

In the BIOS Setup program, the user can choose to boot from a diskette drive, hard drives, CD-ROM, or the network. The default setting is for the diskette drive to be the first boot device, the hard drive second, and the ATAPI CD-ROM third. The fourth device is disabled.

3.8.1 CD-ROM Boot

Booting from CD-ROM is supported in compliance to the El Torito bootable CD-ROM format specification. Under the Boot menu in the BIOS Setup program, ATAPI CD-ROM is listed as a boot device. Boot devices are defined in priority order. Accordingly, if there is not a bootable CD in the CD-ROM drive, the system will attempt to boot from the next defined drive.

| For information about | Refer to |
|-----------------------------|----------------------|
| The El Torito specification | Section 1.5, page 17 |

3.8.2 Network Boot

The network can be selected as a boot device. This selection allows booting from the onboard LAN or a network add-in card with a remote boot ROM installed.

Pressing the <F12> key during POST automatically forces boot from the LAN.

3.8.3 Booting Without Attached Devices

For use in embedded applications, the BIOS has been designed so that after passing the POST, the operating system loader is invoked even if the following devices are not present:

- Video adapter
- Keyboard
- Mouse

3.8.4 Changing the Default Boot Device During POST

Pressing the <F10> key during POST causes a boot device menu to be displayed. This menu displays the list of available boot devices (as set in the BIOS setup program's Boot Device Priority Submenu). Table 44 lists the boot device menu options.

Table 44. Boot Device Menu Options

| Boot Device Menu Function Keys | Description |
|--------------------------------|---|
| <↑> or <↓> | Selects a default boot device |
| <Enter> | Exits the menu, saves changes, and boots from the selected device |
| <Esc> | Exits the menu without saving changes |

3.9 Fast Booting Systems with Intel® Rapid BIOS Boot

These factors affect system boot speed:

- Selecting and configuring peripherals properly
- Using an optimized BIOS, such as the Intel® Rapid BIOS

3.9.1 Peripheral Selection and Configuration

The following techniques help improve system boot speed:

- Choose a hard drive with parameters such as “power-up to data ready” less than eight seconds, that minimize hard drive startup delays.
- Select a CD-ROM drive with a fast initialization rate. This rate can influence POST execution time.
- Eliminate unnecessary add-in adapter features, such as logo displays, screen repaints, or mode changes in POST. These features may add time to the boot process.
- Try different monitors. Some monitors initialize and communicate with the BIOS more quickly, which enables the system to boot more quickly.

3.9.2 Intel Rapid BIOS Boot

Use of the following BIOS Setup program settings reduces the POST execution time.

In the Boot Menu:

- Set the hard disk drive as the first boot device. As a result, the POST does not first seek a diskette drive, which saves about one second from the POST execution time.
- Disable Quiet Boot, which eliminates display of the logo splash screen. This could save several seconds of painting complex graphic images and changing video modes.
- Enabled Intel Rapid BIOS Boot. This feature bypasses memory count and the search for a diskette drive.

In the Peripheral Configuration submenu, disable the LAN device if it will not be used. This can reduce up to four seconds of option ROM boot time.

NOTE

It is possible to optimize the boot process to the point where the system boots so quickly that the Intel logo screen (or a custom logo splash screen) will not be seen. Monitors and hard disk drives with minimum initialization times can also contribute to a boot time that might be so fast that necessary logo screens and POST messages cannot be seen.

This boot time may be so fast that some drives might be not be initialized at all. If this condition should occur, it is possible to introduce a programmable delay ranging from three to 30 seconds (using the Hard Disk Pre-Delay feature of the Advanced Menu in the IDE Configuration Submenu of the BIOS Setup program).

For information about

IDE Configuration Submenu in the BIOS Setup program

Refer to

Section 4.4.4, page 85

3.10 BIOS Security Features

The BIOS includes security features that restrict access to the BIOS Setup program and who can boot the computer. A supervisor password and a user password can be set for the BIOS Setup program and for booting the computer, with the following restrictions:

- The supervisor password gives unrestricted access to view and change all the Setup options in the BIOS Setup program. This is the supervisor mode.
- The user password gives restricted access to view and change Setup options in the BIOS Setup program. This is the user mode.
- If only the supervisor password is set, pressing the <Enter> key at the password prompt of the BIOS Setup program allows the user restricted access to Setup.
- If both the supervisor and user passwords are set, users can enter either the supervisor password or the user password to access Setup. Users have access to Setup respective to which password is entered.
- Setting the user password restricts who can boot the computer. The password prompt will be displayed before the computer is booted. If only the supervisor password is set, the computer boots without asking for a password. If both passwords are set, the user can enter either password to boot the computer.

Table 45 shows the effects of setting the supervisor password and user password. This table is for reference only and is not displayed on the screen.

Table 45. Supervisor and User Password Functions

| Password Set | Supervisor Mode | User Mode | Setup Options | Password to Enter Setup | Password During Boot |
|-------------------------|--|--|---------------------------------------|-------------------------|----------------------|
| Neither | Can change all options <small>(Note)</small> | Can change all options <small>(Note)</small> | None | None | None |
| Supervisor only | Can change all options | Can change a limited number of options | Supervisor Password | Supervisor | None |
| User only | N/A | Can change all options | Enter Password Clear User Password | User | User |
| Supervisor and user set | Can change all options | Can change a limited number of options | Supervisor Password Enter Password | Supervisor or user | Supervisor or user |

Note: If no password is set, any user can change all Setup options.

For information about

Setting user and supervisor passwords

Refer to

Section 4.5, page 94

4 BIOS Setup Program

What This Chapter Contains

| | | |
|-----|------------------------|-----|
| 4.1 | Introduction..... | 77 |
| 4.2 | Maintenance Menu | 78 |
| 4.3 | Main Menu..... | 79 |
| 4.4 | Advanced Menu..... | 80 |
| 4.5 | Security Menu | 94 |
| 4.6 | Power Menu | 95 |
| 4.7 | Boot Menu | 96 |
| 4.8 | Exit Menu | 100 |

4.1 Introduction

The BIOS Setup program can be used to view and change the BIOS settings for the computer. The BIOS Setup program is accessed by pressing the <F2> key after the Power-On Self-Test (POST) memory test begins and before the operating system boot begins. The menu bar is shown below.

| | | | | | | |
|-------------|------|----------|----------|-------|------|------|
| Maintenance | Main | Advanced | Security | Power | Boot | Exit |
|-------------|------|----------|----------|-------|------|------|

Table 46 lists the BIOS Setup program menu features.

Table 46. BIOS Setup Program Menu Bar

| Maintenance | Main | Advanced | Security | Power | Boot | Exit |
|--|---|--|--------------------------------------|--------------------------------------|--|--|
| Clears passwords and BIS credentials and enables extended configuration mode | Allocates resources for hardware components | Configures advanced features available through the chipset | Sets passwords and security features | Configures power management features | Selects boot options and power supply controls | Saves or discards changes to Setup program options |

For information about

Boot Integrity Services (BIS)

Refer to

Section 1.5, page 17

 **NOTE**

In this chapter, all examples of the BIOS Setup program menu bar include the maintenance menu; however, the maintenance menu is displayed only when the Desktop Board is in configuration mode. Section 2.9.2 on page 59 tells how to put the Desktop Board in configuration mode.

Table 47 lists the function keys available for menu screens.

Table 47. BIOS Setup Program Function Keys

| BIOS Setup Program Function Key | Description |
|---------------------------------|--|
| <←> or <→> | Selects a different menu screen (Moves the cursor left or right) |
| <↑> or <↓> | Selects an item (Moves the cursor up or down) |
| <Tab> | Selects a field (Not implemented) |
| <Enter> | Executes command or selects the submenu |
| <F9> | Load the default configuration values for the current menu |
| <F10> | Save the current values and exits the BIOS Setup program |
| <Esc> | Exits the menu |

4.2 Maintenance Menu

To access this menu, select Maintenance on the menu bar at the top of the screen.

| | | | | | | |
|--------------------|------|----------|----------|-------|------|------|
| Maintenance | Main | Advanced | Security | Power | Boot | Exit |
|--------------------|------|----------|----------|-------|------|------|

The menu shown in Table 48 is for clearing Setup passwords and enabling extended configuration mode. Setup only displays this menu in configuration mode.

Table 48. Maintenance Menu

| Feature | Options | Description |
|-------------------------------|---|---|
| Clear All Passwords | <ul style="list-style-type: none"> • Ok (default) • Cancel | Clears the user and supervisor passwords. |
| Clear BIS Credentials | <ul style="list-style-type: none"> • Ok (default) • Cancel | Clears the Wired for Management Boot Integrity Service (BIS) credentials. |
| CPU Stepping Signature | No options | Displays CPU's Stepping Signature. |
| CPU Microcode Update Revision | No options | Displays CPU's Microcode Update Revision. |

4.3 Main Menu

To access this menu, select Main on the menu bar at the top of the screen.

| | | | | | | |
|-------------|-------------|----------|----------|-------|------|------|
| Maintenance | Main | Advanced | Security | Power | Boot | Exit |
|-------------|-------------|----------|----------|-------|------|------|

Table 49 describes the Main menu. This menu reports processor and memory information and is for configuring the system date and system time.

Table 49. Main Menu

| Feature | Options | Description |
|--------------------------------|---|---|
| BIOS Version | No options | Displays the version of the BIOS. |
| Processor Type | No options | Displays processor type. |
| Processor Speed | No options | Displays processor speed. |
| System Bus Speed | No options | Displays the system bus speed. |
| System Memory Speed | No options | Displays the system memory speed. |
| Cache RAM | No options | Displays the size of second-level cache. |
| Total Memory | No options | Displays the total amount of RAM. |
| Memory Bank 0 Memory Bank 1 | No options | Displays the amount and type of RAM in the memory banks. |
| Language | <ul style="list-style-type: none"> • English (default) • Español | Selects the current default language used by the BIOS. |
| Additional System Information | No options | Displays the system Desktop Management Interface (DMI) information. |
| System Time | Hour, minute, and second | Specifies the current time. |
| System Date | Day of week Month/day/year | Specifies the current date. |

4.4 Advanced Menu

To access this menu, select Advanced on the menu bar at the top of the screen.

| | | | | | | |
|-------------|------|--------------------------|----------|-------|------|------|
| Maintenance | Main | Advanced | Security | Power | Boot | Exit |
| | | PCI Configuration | | | | |
| | | Boot Configuration | | | | |
| | | Peripheral Configuration | | | | |
| | | IDE Configuration | | | | |
| | | Diskette Configuration | | | | |
| | | Event Log Configuration | | | | |
| | | Video Configuration | | | | |
| | | USB Configuration | | | | |
| | | Chipset Configuration | | | | |

Table 50 describes the Advanced Menu. This menu is used for setting advanced features that are available through the chipset.

Table 50. Advanced Menu

| Feature | Options | Description |
|--------------------------|---------------------------|--|
| PCI Configuration | Select to display submenu | Configures individual PCI slot's IRQ priority. |
| Boot Configuration | Select to display submenu | Configures Plug and Play and the Numlock key, and resets configuration data. |
| Peripheral Configuration | Select to display submenu | Configures peripheral ports and devices. |
| IDE Configuration | Select to display submenu | Specifies type of connected IDE devices. |
| Diskette Configuration | Select to display submenu | Configures the diskette drive. |
| Event Log Configuration | Select to display submenu | Configures Event Logging. |
| Video Configuration | Select to display submenu | Configures video features. |
| USB Configuration | Select to display submenu | Configures USB support. |
| Chipset Configuration | Select to display submenu | Configures advanced chipset features. |

4.4.1 PCI Configuration Submenu

To access this submenu, select Advanced on the menu bar and then PCI Configuration.

| | | | | | | |
|-------------|------|--------------------------|----------|-------|------|------|
| Maintenance | Main | Advanced | Security | Power | Boot | Exit |
| | | PCI Configuration | | | | |
| | | Boot Configuration | | | | |
| | | Peripheral Configuration | | | | |
| | | IDE Configuration | | | | |
| | | Diskette Configuration | | | | |
| | | Event Log Configuration | | | | |
| | | Video Configuration | | | | |
| | | USB Configuration | | | | |
| | | Chipset Configuration | | | | |

The submenu shown in Table 51 is used to configure the IRQ priority of PCI slots individually.

Table 51. PCI Configuration Submenu

| Feature | Options | Description |
|----------------------------------|---|---|
| PCI Slot1 IRQ Priority (Note) | <ul style="list-style-type: none"> • Auto (default) • 5 • 9 • 10 • 11 | Allows selection of IRQ priority for PCI bus connector 1. |
| PCI Slot2 IRQ Priority (Note) | <ul style="list-style-type: none"> • Auto (default) • 5 • 9 • 10 • 11 | Allows selection of IRQ priority for PCI bus connector 2. |
| PCI Slot3 IRQ Priority (Note) | <ul style="list-style-type: none"> • Auto (default) • 5 • 9 • 10 • 11 | Allows selection of IRQ priority for PCI bus connector 3. |

Note: Additional interrupts may be available if certain onboard devices (such as the serial and parallel ports) are disabled.

4.4.2 Boot Configuration Submenu

To access this submenu, select Advanced on the menu bar and then Boot Configuration.

| | | | | | | |
|-------------|------|---------------------------|----------|-------|------|------|
| Maintenance | Main | Advanced | Security | Power | Boot | Exit |
| | | PCI Configuration | | | | |
| | | Boot Configuration | | | | |
| | | Peripheral Configuration | | | | |
| | | IDE Configuration | | | | |
| | | Diskette Configuration | | | | |
| | | Event Log Configuration | | | | |
| | | Video Configuration | | | | |
| | | USB Configuration | | | | |
| | | Chipset Configuration | | | | |

The submenu represented by Table 52 is for setting Plug and Play options, resetting configuration data, and the power-on state of the Numlock key.

Table 52. Boot Configuration Submenu

| Feature | Options | Description |
|-----------------|--|---|
| Plug & Play O/S | <ul style="list-style-type: none"> • No (default) • Yes | Specifies if manual configuration is desired. <i>No</i> lets the BIOS configure all devices. This setting is appropriate when using a Plug and Play operating system. <i>Yes</i> lets the operating system configure Plug and Play devices not required to boot the system. This option is available for use during lab testing. |
| Numlock | <ul style="list-style-type: none"> • Off • On (default) | Specifies the power-on state of the Numlock feature on the numeric keypad of the keyboard. |
| ASF Support | <ul style="list-style-type: none"> • Disabled • Enabled (default) | Allows disabling the Alert Standard Format (ASF) feature. |

4.4.3 Peripheral Configuration Submenu

To access this submenu, select Advanced on the menu bar and then Peripheral Configuration.

| | | | | | | |
|-------------|------|---------------------------------|----------|-------|------|------|
| Maintenance | Main | Advanced | Security | Power | Boot | Exit |
| | | PCI Configuration | | | | |
| | | Boot Configuration | | | | |
| | | Peripheral Configuration | | | | |
| | | IDE Configuration | | | | |
| | | Diskette Configuration | | | | |
| | | Event Log Configuration | | | | |
| | | Video Configuration | | | | |
| | | USB Configuration | | | | |
| | | Chipset Configuration | | | | |

The submenu represented in Table 53 is used for configuring computer peripherals.

Table 53. Peripheral Configuration Submenu

| Feature | Options | Description |
|---|--|---|
| Serial Port A | <ul style="list-style-type: none"> Disabled Enabled Auto (default) | <p>Configures serial port A.</p> <p><i>Auto</i> assigns the first free COM port, normally COM1, the address 3F8h, and the interrupt IRQ4.</p> <p>An * (asterisk) displayed next to an address indicates a conflict with another device.</p> |
| Base I/O address (This feature is present only when Serial Port A is set to <i>Enabled</i>) | <ul style="list-style-type: none"> 3F8 (default) 2F8 3E8 2E8 | <p>Specifies the base I/O address for serial port A, if serial port A is Enabled.</p> |
| Interrupt (This feature is present only when Serial Port A is set to <i>Enabled</i>) | <ul style="list-style-type: none"> IRQ 3 IRQ 4 (default) | <p>Specifies the interrupt for serial port A, if serial port A is Enabled.</p> |
| Parallel port | <ul style="list-style-type: none"> Disabled Enabled Auto (default) | <p>Configures the parallel port.</p> <p><i>Auto</i> assigns LPT1 the address 378h and the interrupt IRQ7.</p> <p>An * (asterisk) displayed next to an address indicates a conflict with another device.</p> |
| Mode | <ul style="list-style-type: none"> Output Only Bi-directional (default) EPP ECP | <p>Selects the mode for the parallel port. Not available if the parallel port is disabled.</p> <p><i>Output Only</i> operates in AT[†]-compatible mode.</p> <p><i>Bi-directional</i> operates in PS/2-compatible mode.</p> <p><i>EPP</i> is Extended Parallel Port mode, a high-speed bi-directional mode.</p> <p><i>ECP</i> is Enhanced Capabilities Port mode, a high-speed bi-directional mode.</p> |

continued

Table 53. Peripheral Configuration Submenu (continued)

| Feature | Options | Description |
|---|--|---|
| Base I/O address (This feature is present only when Parallel Port is set to <i>Enabled</i>) | <ul style="list-style-type: none"> • 378 (default) • 278 | Specifies the base I/O address for the parallel port. |
| Interrupt (This feature is present only when Parallel Port is set to <i>Enabled</i>) | <ul style="list-style-type: none"> • IRQ 5 • IRQ 7 (default) | Specifies the interrupt for the parallel port. |
| DMA (This feature is present only when Parallel Port Mode is set to <i>ECP</i>) | <ul style="list-style-type: none"> • 1 • 3 (default) | Specifies the DMA channel. |
| Audio Device | <ul style="list-style-type: none"> • Enabled (default) • Disabled | Enables or disables the onboard audio subsystem. For boards with no onboard audio subsystem, this option does not appear. |
| LAN Device | <ul style="list-style-type: none"> • Disabled • Enabled (default) | Enables or disables the onboard LAN device. For boards with no onboard LAN subsystem, this option will not appear. |

4.4.4 IDE Configuration Submenu

To access this submenu, select Advanced on the menu bar and then IDE Configuration.

| | | | | | | |
|-------------|------|--------------------------|----------|-------|------|------|
| Maintenance | Main | Advanced | Security | Power | Boot | Exit |
| | | PCI Configuration | | | | |
| | | Boot Configuration | | | | |
| | | Peripheral Configuration | | | | |
| | | IDE Configuration | | | | |
| | | Diskette Configuration | | | | |
| | | Event Log Configuration | | | | |
| | | Video Configuration | | | | |
| | | USB Configuration | | | | |
| | | Chipset Configuration | | | | |

The menu represented in Table 54 is used to configure IDE device options.

Table 54. IDE Configuration Submenu

| Feature | Options | Description |
|----------------------|--|--|
| IDE Controller | <ul style="list-style-type: none"> Disabled Primary Secondary Both (default) | Specifies the integrated IDE controller. <i>Primary</i> enables only the primary IDE controller. <i>Secondary</i> enables only the secondary IDE controller. <i>Both</i> enables both IDE controllers. |
| PCI IDE Bus Master | <ul style="list-style-type: none"> Disabled Enabled (default) | Enables/disables the use of DMA for hard drive BIOS INT13 reads and writes. |
| Hard Disk Pre-Delay | <ul style="list-style-type: none"> Disabled (default) 3 Seconds 6 Seconds 9 Seconds 12 Seconds 15 Seconds 21 Seconds 30 Seconds | Specifies the hard disk drive pre-delay. |
| Primary IDE Master | Select to display sub-menu | Reports type of connected IDE device. |
| Primary IDE Slave | Select to display sub-menu | Reports type of connected IDE device. |
| Secondary IDE Master | Select to display sub-menu | Reports type of connected IDE device. |
| Secondary IDE Slave | Select to display sub-menu | Reports type of connected IDE device. |

4.4.4.1 Primary/Secondary IDE Master/Slave Submenus

To access these submenus, select **Advanced** on the menu bar, then **IDE Configuration**, and then the master or slave to be configured.

| | | | | | | |
|-------------|------|-----------------------------|----------|-------|------|------|
| Maintenance | Main | Advanced | Security | Power | Boot | Exit |
| | | PCI Configuration | | | | |
| | | Boot Configuration | | | | |
| | | Peripheral Configuration | | | | |
| | | IDE Configuration | | | | |
| | | Primary IDE Master | | | | |
| | | Primary IDE Slave | | | | |
| | | Secondary IDE Master | | | | |
| | | Secondary IDE Slave | | | | |
| | | Diskette Configuration | | | | |
| | | Event Log Configuration | | | | |
| | | Video Configuration | | | | |
| | | USB Configuration | | | | |
| | | Chipset Configuration | | | | |

There are four IDE submenus: primary master, primary slave, secondary master, and secondary slave. Table 55 shows the format of the IDE submenus. For brevity, only one example is shown.

Table 55. Primary/Secondary IDE Master/Slave Submenus

| Feature | Options | Description |
|------------------|---|---|
| Drive Installed | No options | Displays the type of drive installed. |
| Type | <ul style="list-style-type: none"> • Auto (default) • User | Specifies the IDE configuration mode for IDE devices. <i>User</i> allows capabilities to be changed. <i>Auto</i> fills-in capabilities from ATA/ATAPI device. |
| Maximum Capacity | No options | Displays the capacity of the drive. |
| LBA/Large Mode | <ul style="list-style-type: none"> • Disabled • Auto (default) | Selects the translation mode for the IDE hard disk. (This item is read-only unless Type is set to <i>User</i> .) |

continued

Table 55. Primary/Secondary IDE Master/Slave Submenus (continued)

| Feature | Options | Description |
|----------------|---|--|
| Block Mode | <ul style="list-style-type: none"> • Disabled • Auto (default) | <p>Disabled = Data transfers to/from the device occur one sector at a time.</p> <p>Auto = Data transfers to/from the device occur multiple sectors at a time if the device supports block mode transfers.</p> <p>(This item is read-only unless Type is set to <i>User</i>.)</p> |
| PIO Mode | <ul style="list-style-type: none"> • Auto (default) • 0 • 1 • 2 • 3 • 4 | <p>Specifies the PIO mode.</p> <p>(This item is read-only unless Type is set to <i>User</i>.)</p> |
| DMA Mode | <ul style="list-style-type: none"> • Auto (default) • SWDMA0 • SWDMA1 • SWDMA2 • MWDMA0 • MWDMA1 • MWDMA2 • UDMA0 • UDMA1 • UDMA2 • UDMA3 • UDMA4 • UDMA5 | <p>Specifies the DMA mode for the drive.</p> <p><i>Auto</i> = Auto-detected</p> <p><i>SWDMA_n</i> = Single Word DMA_n</p> <p><i>MWDMA_n</i> = Multi Word DMA_n</p> <p><i>UDMA_n</i> = Ultra DMA_n</p> <p>(This item is read-only unless Type is set to <i>User</i>.)</p> |
| S.M.A.R.T. | <ul style="list-style-type: none"> • Auto (default) • Disabled • Enabled | <p>Enables/disables S.M.A.R.T. (Self-Monitoring, Analysis, and Reporting Technology).</p> <p>(This item is read-only unless Type is set to <i>User</i>.)</p> |
| Cable Detected | No options | <p>Displays the type of cable connected to the IDE interface: 40-conductor or 80-conductor (for ATA-100 peripherals).</p> |

Note: If an LS-120 drive is attached to the system, a row entitled ARMD Emulation Type will be displayed in the above table. The BIOS will always recognize the drive as an ATAPI floppy drive. The ARMD Emulation Type should always be set to Floppy.

4.4.5 Diskette Configuration Submenu

To access this menu, select Advanced on the menu bar and then Diskette Configuration.

| | | | | | | |
|-------------|------|-------------------------------|----------|-------|------|------|
| Maintenance | Main | Advanced | Security | Power | Boot | Exit |
| | | PCI Configuration | | | | |
| | | Boot Configuration | | | | |
| | | Peripheral Configuration | | | | |
| | | IDE Configuration | | | | |
| | | Diskette Configuration | | | | |
| | | Event Log Configuration | | | | |
| | | Video Configuration | | | | |
| | | USB Configuration | | | | |
| | | Chipset Configuration | | | | |

The submenu represented by Table 56 is used for configuring the diskette drive.

Table 56. Diskette Configuration Submenu

| Feature | Options | Description |
|------------------------|---|---|
| Diskette Controller | <ul style="list-style-type: none"> Disabled Enabled (default) | Disables or enables the integrated diskette controller. |
| Floppy A | <ul style="list-style-type: none"> Not Installed 360 KB 5¼" 1.2 MB 5¼" 720 KB 3½" 1.44/1.25 MB 3½" (default) 2.88 MB 3½" | Specifies the capacity and physical size of diskette drive A. |
| Diskette Write Protect | <ul style="list-style-type: none"> Disabled (default) Enabled | Disables or enables write protection for the diskette drive. |

4.4.6 Event Log Configuration Submenu

To access this menu, select Advanced on the menu bar and then Event Log Configuration.

| | | | | | | |
|-------------|------|--------------------------------|----------|-------|------|------|
| Maintenance | Main | Advanced | Security | Power | Boot | Exit |
| | | PCI Configuration | | | | |
| | | Boot Configuration | | | | |
| | | Peripheral Configuration | | | | |
| | | IDE Configuration | | | | |
| | | Diskette Configuration | | | | |
| | | Event Log Configuration | | | | |
| | | Video Configuration | | | | |
| | | USB Configuration | | | | |
| | | Chipset Configuration | | | | |

The submenu represented by Table 57 is used to configure the event logging features.

Table 57. Event Log Configuration Submenu

| Feature | Options | Description |
|---------------------|--|---|
| Event Log | No options | Indicates if there is space available in the event log. |
| View Event Log | [Enter] | Displays the event log. |
| Clear Event Log | <ul style="list-style-type: none"> • Ok (default) • Cancel | Clears the event log after rebooting. |
| Event Logging | <ul style="list-style-type: none"> • Disabled • Enabled (default) | Enables logging of events. |
| Mark Events As Read | <ul style="list-style-type: none"> • Ok (default) • Cancel | Marks all events as read. |

4.4.7 Video Configuration Submenu

To access this menu, select Advanced on the menu bar and then Video Configuration.

| | | | | | | |
|-------------|------|----------------------------|----------|-------|------|------|
| Maintenance | Main | Advanced | Security | Power | Boot | Exit |
| | | PCI Configuration | | | | |
| | | Boot Configuration | | | | |
| | | Peripheral Configuration | | | | |
| | | IDE Configuration | | | | |
| | | Diskette Configuration | | | | |
| | | Event Log Configuration | | | | |
| | | Video Configuration | | | | |
| | | USB Configuration | | | | |
| | | Chipset Configuration | | | | |

The submenu represented in Table 58 is for configuring the video features.

Table 58. Video Configuration Submenu

| Feature | Options | Description |
|-----------------------|--|---|
| AGP Aperture Size | <ul style="list-style-type: none"> • 4 MB • 8 MB • 16 MB • 32 MB • 64 MB (default) • 128 MB • 256 MB | Sets the aperture size for the video controller. |
| Primary Video Adapter | <ul style="list-style-type: none"> • Integrated Graphics (default) • PCI | Selects primary video adapter to be used during boot. |
| Frame Buffer Size | <ul style="list-style-type: none"> • 512 KB • 1 MB (default) • 8 MB | Sets the frame buffer size. |

4.4.8 USB Configuration Submenu

To access this menu, select Advanced on the menu bar and then USB Configuration.

| | | | | | | |
|-------------|------|--------------------------|----------|-------|------|------|
| Maintenance | Main | Advanced | Security | Power | Boot | Exit |
| | | PCI Configuration | | | | |
| | | Boot Configuration | | | | |
| | | Peripheral Configuration | | | | |
| | | IDE Configuration | | | | |
| | | Diskette Configuration | | | | |
| | | Event Log Configuration | | | | |
| | | Video Configuration | | | | |
| | | USB Configuration | | | | |
| | | Chipset Configuration | | | | |

The submenu represented in Table 59 is for configuring the USB features.

Table 59. USB Configuration Submenu

| Feature | Options | Description |
|------------------------|---|---|
| High-Speed USB | <ul style="list-style-type: none"> • Disabled • Enabled (default) | Set to <i>Disabled</i> when a USB 2.0 driver is not available. |
| Legacy USB Support | <ul style="list-style-type: none"> • Disabled • Enabled (default) | Enables/disables legacy USB support. |
| USB 2.0 Legacy Support | <ul style="list-style-type: none"> • Fullspeed (default) • Hispeed | Configures the USB 2.0 legacy support to Hi-Speed (480 Mbps) or Full-Speed (12 Mbps). |

4.4.9 Chipset Configuration Submenu

To access this menu, select Advanced on the menu bar and then Chipset Configuration.

| | | | | | | |
|-------------|------|------------------------------|----------|-------|------|------|
| Maintenance | Main | Advanced | Security | Power | Boot | Exit |
| | | PCI Configuration | | | | |
| | | Boot Configuration | | | | |
| | | Peripheral Configuration | | | | |
| | | IDE Configuration | | | | |
| | | Diskette Configuration | | | | |
| | | Event Log Configuration | | | | |
| | | Video Configuration | | | | |
| | | USB Configuration | | | | |
| | | Chipset Configuration | | | | |

The submenu represented in Table 60 is for configuring chipset options.

Table 60. Chipset Configuration Submenu

| Feature | Options | Description |
|------------------------|--|---|
| ISA Enable Bit | <ul style="list-style-type: none"> • Disabled (default) • Enabled | When set to <i>Enable</i> , a PCI-to-PCI bridge will only recognize I/O addresses that do not alias to an ISA range (within the bridge's assigned I/O range). |
| PCI Latency Timer | <ul style="list-style-type: none"> • 32 (default) • 64 • 96 • 128 • 160 • 192 • 224 • 248 | Allows you to control the time (in PCI bus clock cycles) that an agent on the PC bus can hold the bus when another agent has requested the bus. |
| Extended Configuration | <ul style="list-style-type: none"> • Default (default) • User Defined | Allows the setting of extended configuration options. |
| SDRAM Frequency | <ul style="list-style-type: none"> • Auto (default) • 200 MHz • 266 MHz • 333 MHz | Allows override of detected memory frequency value. NOTE: If SDRAM Frequency is changed, you must reboot for the change to take effect. Also, after changing this setting and rebooting, the System Memory Speed parameter in the Main menu will reflect the new value |

continued

Table 60. Chipset Configuration Submenu (continued)

| Feature | Options | Description |
|--------------------------------|---|--|
| SDRAM Timing Control | <ul style="list-style-type: none"> • Auto (default) • Manual – Aggressive • Manual – User Defined | <p><i>Auto</i> = Timings will be programmed according to the memory detected.</p> <p><i>Manual – Aggressive</i> = Selects most aggressive user-defined timings.</p> <p><i>Manual – User Defined</i> = Allows manual override of detected SDRAM settings.</p> |
| SDRAM RAS# Active to Precharge | <ul style="list-style-type: none"> • 7 • 6 • 5 (default) | Corresponds to tRAS. |
| SDRAM CAS# Latency | <ul style="list-style-type: none"> • 2.0 (default) • 2.5 | Selects the number of clock cycles required to address a column in memory. |
| SDRAM RAS# to CAS# Delay | <ul style="list-style-type: none"> • 3 • 2 (default) | Selects the number of clock cycles between addressing a row and addressing a column. |
| SDRAM RAS# Precharge | <ul style="list-style-type: none"> • 3 • 2 (default) | Selects the length of time required before accessing a new row. |

4.5 Security Menu

To access this menu, select Security from the menu bar at the top of the screen.

| | | | | | | |
|-------------|------|----------|-----------------|-------|------|------|
| Maintenance | Main | Advanced | Security | Power | Boot | Exit |
|-------------|------|----------|-----------------|-------|------|------|

The menu represented by Table 61 is for setting passwords and security features.

Table 61. Security Menu

| Feature | Options | Description |
|---------------------------------|---|--|
| Supervisor Password | No options | Reports if there is a supervisor password set. |
| User Password | No options | Reports if there is a user password set. |
| Set Supervisor Password | Password can be up to seven alphanumeric characters. | Specifies the supervisor password. |
| User Access Level (Note 1) | <ul style="list-style-type: none"> • No Access • View Only • Limited • Full (default) | Sets BIOS Setup Utility access rights for user level. |
| Set User Password | Password can be up to seven alphanumeric characters. | Specifies the user password. |
| Clear User Password (Note 2) | <ul style="list-style-type: none"> • Ok (default) • Cancel | Clears the user password. |
| Chassis Intrusion | <ul style="list-style-type: none"> • Disabled (default) • Log • Log, notify once • Log, notify until cleared | <p><i>Disabled</i> = Disables Chassis Intrusion</p> <p><i>Log</i> = Logs the intrusion in the event log</p> <p><i>Log, notify once</i> = Halts system during POST. User must press <F4> to continue. Intrusion flag is cleared and the event log is updated.</p> <p><i>Log, notify until cleared</i> = Halts system during POST. User must enter BIOS setup Security Menu and select "Clear Chassis Intrusion Status" to clear the Chassis intrusion flag.</p> |

Notes:

1. This feature appears only if a supervisor password has been set.
2. This feature appears only if a user password has been set.

4.6 Power Menu

To access this menu, select Power from the menu bar at the top of the screen.

| | | | | | | |
|-------------|------|----------|----------|--------------|------|------|
| Maintenance | Main | Advanced | Security | Power | Boot | Exit |
| | | | | ACPI | | |

The menu represented in Table 62 is for setting the power management features.

Table 62. Power Menu

| Feature | Options | Description |
|---------------------|---|--|
| ACPI | Select to display submenu | Sets the ACPI power management options. |
| After Power Failure | <ul style="list-style-type: none"> Stay Off Last State (default) Power On | <p>Specifies the mode of operation if an AC power loss occurs.</p> <p><i>Stay Off</i> keeps the power off until the power button is pressed.</p> <p><i>Last State</i> restores the previous power state before power loss occurred.</p> <p><i>Power On</i> restores power to the computer.</p> |
| Wake on PCI PME | <ul style="list-style-type: none"> Stay Off (default) Power On | Specifies how the computer responds to a PCI power management event. |
| Wake on Modem Ring | <ul style="list-style-type: none"> Stay Off (default) Power On | Specifies how the computer responds to an incoming call on an installed modem when the power is off. |

4.6.1 ACPI Submenu

To access this menu, select Power from the menu bar at the top of the screen and then ACPI.

| | | | | | | |
|-------------|------|----------|----------|--------------|------|------|
| Maintenance | Main | Advanced | Security | Power | Boot | Exit |
| | | | | ACPI | | |

The submenu represented in Table 63 is for setting the ACPI power options.

Table 63. ACPI Submenu

| Feature | Options | Description |
|---------------------|---|---|
| ACPI Suspend State | <ul style="list-style-type: none"> S1 State S3 State (default) | S1 is the safest mode but consumes more power. S3 consumes less power, but some drivers may not support this state. |
| Wake on LAN from S5 | <ul style="list-style-type: none"> Stay Off (default) Power On | In ACPI soft-off mode only, determines how the system responds to a LAN wake-up event. |

4.7 Boot Menu

To access this menu, select Boot from the menu bar at the top of the screen.

| | | | | | | |
|-------------|------|----------|----------|-------|-------------|----------------------|
| Maintenance | Main | Advanced | Security | Power | Boot | Exit |
| | | | | | | Boot Device Priority |
| | | | | | | Hard Disk Drives |
| | | | | | | Removable Devices |
| | | | | | | ATAPI CD-ROM Drives |

The menu represented in Table 64 is used to set the boot features and the boot sequence.

Table 64. Boot Menu

| Feature | Options | Description |
|-----------------------|--|--|
| Silent Boot | <ul style="list-style-type: none"> Disabled Enabled (default) | <p><i>Disabled</i> displays normal POST messages.</p> <p><i>Enabled</i> displays OEM graphic instead of POST messages.</p> |
| Intel Rapid BIOS Boot | <ul style="list-style-type: none"> Disabled Enabled (default) | Enables the computer to boot without running certain POST tests. |
| Scan User Flash Area | <ul style="list-style-type: none"> Disabled Enabled (default) | Enables the BIOS to scan the flash memory for user binary files that are executed at boot time. |
| PXE Boot to LAN | <ul style="list-style-type: none"> Disabled (default) Enabled | <p>Disables/enables PXE boot to LAN.</p> <p>Note: When set to <i>Enabled</i>, you must reboot for the Intel Boot Agent device to be available in the Boot Device menu.</p> |
| USB Boot | <ul style="list-style-type: none"> Disabled Enabled (default) | Disables/enables booting to USB boot devices. |
| Boot Device Priority | Select to display submenu | Specifies the boot sequence from the available types of boot devices. |
| Hard Disk Drives | Select to display submenu | Specifies the boot sequence from the available hard disk drives. |
| Removable Devices | Select to display submenu | Specifies the boot sequence from the available removable devices. |
| ATAPI CD-ROM Drives | Select to display submenu | Specifies the boot sequence from the available ATAPI CD-ROM drives. |

4.7.1 Boot Device Priority Submenu

To access this menu, select Boot on the menu bar and then Boot Devices Priority.

| | | | | | | |
|-------------|------|----------|----------|-------|-------------|-----------------------------|
| Maintenance | Main | Advanced | Security | Power | Boot | Exit |
| | | | | | | Boot Device Priority |
| | | | | | | Hard Disk Drives |
| | | | | | | Removable Devices |
| | | | | | | ATAPI CD-ROM Drives |

The submenu represented in Table 65 is for setting boot devices priority.

Table 65. Boot Device Priority Submenu

| Feature | Options | Description |
|-----------------------------|--|---|
| 1 st Boot Device | <ul style="list-style-type: none"> • Removable Dev. • Hard Drive • ATAPI CD-ROM • Intel® Boot Agent (Note) • Disabled | <p>Specifies the boot sequence according to the device type. The computer will attempt to boot from up to five devices as specified here. Only one of the devices can be an IDE hard disk drive. To specify boot sequence:</p> <ol style="list-style-type: none"> 1. Select the boot device with <↑> or <↓>. 2. Press <Enter> to set the selection as the intended boot device. <p>The default settings for the first through fourth boot devices are, respectively:</p> <ul style="list-style-type: none"> • Removable Dev. • Hard Drive • ATAPI CD-ROM • Intel Boot Agent |
| 2 nd Boot Device | | |
| 3 rd Boot Device | | |
| 4 th Boot Device | | |

Note: The boot device identifier for Intel Boot Agent (IBA) may vary depending on the BIOS release.

4.7.2 Hard Disk Drives Submenu

To access this menu, select Boot on the menu bar and then Hard Disk Drives.

| | | | | | | |
|-------------|------|----------|----------|-------|-------------|-------------------------|
| Maintenance | Main | Advanced | Security | Power | Boot | Exit |
| | | | | | | Boot Device Priority |
| | | | | | | Hard Disk Drives |
| | | | | | | Removable Devices |
| | | | | | | ATAPI CD-ROM Drives |

The submenu represented in Table 66 is for setting hard disk drive priority.

Table 66. Hard Disk Drives Submenu

| Feature | Options | Description |
|---|------------------------------------|--|
| 1 st Hard Disk Drive (Note) | Dependent on installed hard drives | Specifies the boot sequence from the available hard disk drives. To specify boot sequence: 1. Select the boot device with <↑> or <↓>. 2. Press <Enter> to set the selection as the intended boot device. |

Note: This boot device submenu appears only if at least one boot device of this type is installed. This list will display up to twelve hard disk drives, the maximum number of hard disk drives supported by the BIOS.

4.7.3 Removable Devices Submenu

To access this menu, select Boot on the menu bar, then Removable Devices.

| | | | | | | |
|-------------|------|----------|----------|-------|-------------|--------------------------|
| Maintenance | Main | Advanced | Security | Power | Boot | Exit |
| | | | | | | Boot Device Priority |
| | | | | | | Hard Disk Drives |
| | | | | | | Removable Devices |
| | | | | | | ATAPI CD-ROM Drives |

The submenu represented in Table 67 is for setting removable device priority.

Table 67. Removable Devices Submenu

| Feature | Options | Description |
|--|--|---|
| 1 st Removable Device (Note) | Dependent on installed removable devices | Specifies the boot sequence from the available removable devices. To specify boot sequence: 1. Select the boot device with <↑> or <↓>. 2. Press <Enter> to set the selection as the intended boot device. |

Note: This boot device submenu appears only if at least one boot device of this type is installed. This list will display up to four removable devices, the maximum number of removable devices supported by the BIOS.

4.7.4 ATAPI CD-ROM Drives Submenu

To access this menu, select Boot on the menu bar and then ATAPI CD-ROM Drives.

| | | | | | | |
|-------------|------|----------|----------|-------|-------------|----------------------------|
| Maintenance | Main | Advanced | Security | Power | Boot | Exit |
| | | | | | | Boot Device Priority |
| | | | | | | Hard Disk Drives |
| | | | | | | Removable Devices |
| | | | | | | ATAPI CD-ROM Drives |

The submenu represented in Table 68 is for setting ATAPI CD-ROM drive priority.

Table 68. ATAPI CD-ROM Drives Submenu

| Feature | Options | Description |
|---------------------------------------|--|---|
| 1 st ATAPI CDROM (Note) | Dependent on installed ATAPI CD-ROM drives | Specifies the boot sequence from the available ATAPI CD-ROM drives. To specify boot sequence: 1. Select the boot device with <↑> or <↓>. 2. Press <Enter> to set the selection as the intended boot device. |

Note: This boot device submenu appears only if at least one boot device of this type is installed. This list will display up to four ATAPI CD-ROM drives, the maximum number of ATAPI CD-ROM drives supported by the BIOS.

4.8 Exit Menu

To access this menu, select Exit from the menu bar at the top of the screen.

| | | | | | | |
|-------------|------|----------|----------|-------|------|-------------|
| Maintenance | Main | Advanced | Security | Power | Boot | Exit |
|-------------|------|----------|----------|-------|------|-------------|

The menu represented in Table 69 is for exiting the BIOS Setup program, saving changes, and loading and saving defaults.

Table 69. Exit Menu

| Feature | Description |
|-------------------------|--|
| Exit Saving Changes | Exits and saves the changes in CMOS SRAM. |
| Exit Discarding Changes | Exits without saving any changes made in the BIOS Setup program. |
| Load Optimal Defaults | Loads the optimal default values for all the Setup options. |
| Load Custom Defaults | Loads the custom defaults for Setup options. |
| Save Custom Defaults | Saves the current values as custom defaults. Normally, the BIOS reads the Setup values from flash memory. If this memory is corrupted, the BIOS reads the custom defaults. If no custom defaults are set, the BIOS reads the factory defaults. |
| Discard Changes | Discards changes without exiting Setup. The option values present when the computer was turned on are used. |

5 Error Messages and Beep Codes

What This Chapter Contains

| | | |
|-----|--------------------------------------|-----|
| 5.1 | BIOS Error Messages..... | 101 |
| 5.2 | Port 80h POST Codes..... | 103 |
| 5.3 | Bus Initialization Checkpoints | 107 |
| 5.4 | Speaker | 108 |
| 5.5 | BIOS Beep Codes | 108 |

5.1 BIOS Error Messages

Table 70 lists the error messages and provides a brief description of each.

Table 70. BIOS Error Messages

| Error Message | Explanation |
|--|---|
| GA20 Error | An error occurred with Gate A20 when switching to protected mode during the memory test. |
| Pri Master HDD Error Pri Slave HDD Error Sec Master HDD Error Sec Slave HDD Error | Could not read sector from corresponding drive. |
| Pri Master Drive - ATAPI Incompatible Pri Slave Drive - ATAPI Incompatible Sec Master Drive - ATAPI Incompatible Sec Slave Drive - ATAPI Incompatible | Corresponding drive in not an ATAPI device. Run Setup to make sure device is selected correctly. |
| A: Drive Error | No response from diskette drive. |
| Cache Memory Bad | An error occurred when testing L2 cache. Cache memory may be bad. |
| CMOS Battery Low | The battery may be losing power. Replace the battery soon. |
| CMOS Display Type Wrong | The display type is different than what has been stored in CMOS. Check Setup to make sure type is correct. |
| CMOS Checksum Bad | The CMOS checksum is incorrect. CMOS memory may have been corrupted. Run Setup to reset values. |
| CMOS Settings Wrong | CMOS values are not the same as the last boot. These values have either been corrupted or the battery has failed. |
| CMOS Date/Time Not Set | The time and/or date values stored in CMOS are invalid. Run Setup to set correct values. |
| DMA Error | Error during read/write test of DMA controller. |
| FDC Failure | Error occurred trying to access diskette drive controller. |
| HDC Failure | Error occurred trying to access hard disk controller. |

continued

Table 70. BIOS Error Messages (continued)

| Error Message | Explanation |
|---------------------------------------|---|
| Checking NVRAM..... | NVRAM is being checked to see if it is valid. |
| Update OK! | NVRAM was invalid and has been updated. |
| Updated Failed | NVRAM was invalid but was unable to be updated. |
| Keyboard Error | Error in the keyboard connection. Make sure keyboard is connected properly. |
| KB/Interface Error | Keyboard interface test failed. |
| Memory Size Decreased | Memory size has decreased since the last boot. If no memory was removed then memory may be bad. |
| Memory Size Increased | Memory size has increased since the last boot. If no memory was added there may be a problem with the system. |
| Memory Size Changed | Memory size has changed since the last boot. If no memory was added or removed then memory may be bad. |
| No Boot Device Available | System did not find a device to boot. |
| Off Board Parity Error | A parity error occurred on an off-board card. This error is followed by an address. |
| On Board Parity Error | A parity error occurred in onboard memory. This error is followed by an address. |
| Parity Error | A parity error occurred in onboard memory at an unknown address. |
| NVRAM/CMOS/PASSWORD cleared by Jumper | NVRAM, CMOS, and passwords have been cleared. The system should be powered down and the jumper removed. |
| <CTRL_N> Pressed | CMOS is ignored and NVRAM is cleared. User must enter Setup. |

5.2 Port 80h POST Codes

During the POST, the BIOS generates diagnostic progress codes (POST-codes) to I/O port 80h. If the POST fails, execution stops and the last POST code generated is left at port 80h. This code is useful for determining the point where an error occurred.

Displaying the POST-codes requires a PCI bus add-in card, often called a POST card. The POST card can decode the port and display the contents on a medium such as a seven-segment display.

NOTE

The POST card must be installed in PCI bus connector 1.

The tables below offer descriptions of the POST codes generated by the BIOS. Table 71 defines the uncompressed INIT code checkpoints, Table 72 describes the boot block recovery code checkpoints, and Table 73 lists the runtime code uncompressed in F000 shadow RAM. Some codes are repeated in the tables because that code applies to more than one operation.

Table 71. Uncompressed INIT Code Checkpoints

| Code | Description of POST Operation |
|------|---|
| D0 | NMI is Disabled. Onboard KBC, RTC enabled (if present). Init code Checksum verification starting. |
| D1 | Keyboard controller BAT test, CPU ID saved, and going to 4 GB flat mode. |
| D3 | Do necessary chipset initialization, start memory refresh, and do memory sizing. |
| D4 | Verify base memory. |
| D5 | Init code to be copied to segment 0 and control to be transferred to segment 0. |
| D6 | Control is in segment 0. To check recovery mode and verify main BIOS checksum. If either it is recovery mode or main BIOS checksum is bad, go to check point E0 for recovery else go to check point D7 for giving control to main BIOS. |
| D7 | Find Main BIOS module in ROM image. |
| D8 | Uncompress the main BIOS module. |
| D9 | Copy main BIOS image to F000 shadow RAM and give control to main BIOS in F000 shadow RAM. |

Table 72. Boot Block Recovery Code Checkpoints

| Code | Description of POST Operation |
|------|---|
| E0 | Onboard Floppy Controller (if any) is initialized. Compressed recovery code is uncompressed in F000:0000 in Shadow RAM and give control to recovery code in F000 Shadow RAM. Initialize interrupt vector tables, initialize system timer, initialize DMA controller and interrupt controller. |
| E8 | Initialize extra (Intel Recovery) Module. |
| E9 | Initialize floppy drive. |
| EA | Try to boot from floppy. If reading of boot sector is successful, give control to boot sector code. |
| EB | Bootting from floppy failed, look for ATAPI (LS-120, Zip) devices. |
| EC | Try to boot from ATAPI. If reading of boot sector is successful, give control to boot sector code. |
| EF | Bootting from floppy and ATAPI device failed. Give two beeps. Retry the bootting procedure again (go to check point E9). |

Table 73. Runtime Code Uncompressed in F000 Shadow RAM

| Code | Description of POST Operation |
|------|--|
| 03 | NMI is Disabled. To check soft reset/power-on. |
| 05 | BIOS stack set. Going to disable cache if any. |
| 06 | POST code to be uncompressed. |
| 07 | CPU init and CPU data area init to be done. |
| 08 | CMOS checksum calculation to be done next. |
| 0B | Any initialization before keyboard BAT to be done next. |
| 0C | KB controller I/B free. To issue the BAT command to keyboard controller. |
| 0E | Any initialization after KB controller BAT to be done next. |
| 0F | Keyboard command byte to be written. |
| 10 | Going to issue Pin-23,24 blocking/unblocking command. |
| 11 | Going to check pressing of <INS>, <END> key during power-on. |
| 12 | To init CMOS if "Init CMOS in every boot" is set or <END> key is pressed. Going to disable DMA and Interrupt controllers. |
| 13 | Video display is disabled and port-B is initialized. Chipset init about to begin. |
| 14 | 8254 timer test about to start. |
| 19 | About to start memory refresh test. |
| 1A | Memory Refresh line is toggling. Going to check 15 μ s ON/OFF time. |
| 23 | To read 8042 input port and disable Megakey GreenPC feature. Make BIOS code segment writeable. |
| 24 | To do any setup before Int vector init. |
| 25 | Interrupt vector initialization to begin. To clear password if necessary. |
| 27 | Any initialization before setting video mode to be done. |
| 28 | Going for monochrome mode and color mode setting. |
| 2A | Different buses init (system, static, output devices) to start if present. (See Section 5.3 for details of different buses.) |
| 2B | To give control for any setup required before optional video ROM check. |
| 2C | To look for optional video ROM and give control. |
| 2D | To give control to do any processing after video ROM returns control. |
| 2E | If EGA/VGA not found then do display memory R/W test. |
| 2F | EGA/VGA not found. Display memory R/W test about to begin. |
| 30 | Display memory R/W test passed. About to look for the retrace checking. |
| 31 | Display memory R/W test or retrace checking failed. To do alternate Display memory R/W test. |
| 32 | Alternate Display memory R/W test passed. To look for the alternate display retrace checking. |
| 34 | Video display checking over. Display mode to be set next. |
| 37 | Display mode set. Going to display the power-on message. |
| 38 | Different buses init (input, IPL, general devices) to start if present. (See Section 5.3 for details of different buses.) |
| 39 | Display different buses initialization error messages. (See Section 5.3 for details of different buses.) |
| 3A | New cursor position read and saved. To display the Hit message. |

continued

Table 73. Runtime Code Uncompressed in F000 Shadow RAM (continued)

| Code | Description of POST Operation |
|------|---|
| 40 | To prepare the descriptor tables. |
| 42 | To enter in virtual mode for memory test. |
| 43 | To enable interrupts for diagnostics mode. |
| 44 | To initialize data to check memory wrap around at 0:0. |
| 45 | Data initialized. Going to check for memory wrap around at 0:0 and finding the total system memory size. |
| 46 | Memory wrap around test done. Memory size calculation over. About to go for writing patterns to test memory. |
| 47 | Pattern to be tested written in extended memory. Going to write patterns in base 640k memory. |
| 48 | Patterns written in base memory. Going to find out amount of memory below 1M memory. |
| 49 | Amount of memory below 1M found and verified. Going to find out amount of memory above 1M memory. |
| 4B | Amount of memory above 1M found and verified. Check for soft reset and going to clear memory below 1M for soft reset. (If power on, go to check point # 4Eh). |
| 4C | Memory below 1M cleared. (SOFT RESET) Going to clear memory above 1M. |
| 4D | Memory above 1M cleared. (SOFT RESET) Going to save the memory size. (Go to check point # 52h). |
| 4E | Memory test started. (NOT SOFT RESET) About to display the first 64k memory size. |
| 4F | Memory size display started. This will be updated during memory test. Going for sequential and random memory test. |
| 50 | Memory testing/initialization below 1M complete. Going to adjust displayed memory size for relocation/shadow. |
| 51 | Memory size display adjusted due to relocation/ shadow. Memory test above 1M to follow. |
| 52 | Memory testing/initialization above 1M complete. Going to save memory size information. |
| 53 | Memory size information is saved. CPU registers are saved. Going to enter in real mode. |
| 54 | Shutdown successful, CPU in real mode. Going to disable gate A20 line and disable parity/NMI. |
| 57 | A20 address line, parity/NMI disable successful. Going to adjust memory size depending on relocation/shadow. |
| 58 | Memory size adjusted for relocation/shadow. Going to clear Hit message. |
| 59 | Hit message cleared. <WAIT...> message displayed. About to start DMA and interrupt controller test. |
| 60 | DMA page register test passed. To do DMA#1 base register test. |
| 62 | DMA#1 base register test passed. To do DMA#2 base register test. |
| 65 | DMA#2 base register test passed. To program DMA unit 1 and 2. |
| 66 | DMA unit 1 and 2 programming over. To initialize 8259 interrupt controller. |
| 7F | Extended NMI sources enabling is in progress. |
| 80 | Keyboard test started. Clearing output buffer, checking for stuck key, to issue keyboard reset command. |
| 81 | Keyboard reset error/stuck key found. To issue keyboard controller interface test command. |
| 82 | Keyboard controller interface test over. To write command byte and init circular buffer. |
| 83 | Command byte written, global data init done. To check for lock-key. |

continued

Table 73. Runtime Code Uncompressed in F000 Shadow RAM (continued)

| Code | Description of POST Operation |
|------|---|
| 84 | Lock-key checking over. To check for memory size mismatch with CMOS. |
| 85 | Memory size check done. To display soft error and check for password or bypass setup. |
| 86 | Password checked. About to do programming before setup. |
| 87 | Programming before setup complete. To uncompress SETUP code and execute CMOS setup. |
| 88 | Returned from CMOS setup program and screen is cleared. About to do programming after setup. |
| 89 | Programming after setup complete. Going to display power-on screen message. |
| 8B | First screen message displayed. <WAIT...> message displayed. PS/2 Mouse check and extended BIOS data area allocation to be done. |
| 8C | Setup options programming after CMOS setup about to start. |
| 8D | Going for hard disk controller reset. |
| 8F | Hard disk controller reset done. Floppy setup to be done next. |
| 91 | Floppy setup complete. Hard disk setup to be done next. |
| 95 | Init of different buses optional ROMs from C800 to start. (See Section 5.3 for details of different buses.) |
| 96 | Going to do any init before C800 optional ROM control. |
| 97 | Any init before C800 optional ROM control is over. Optional ROM check and control will be done next. |
| 98 | Optional ROM control is done. About to give control to do any required processing after optional ROM returns control and enable external cache. |
| 99 | Any initialization required after optional ROM test over. Going to setup timer data area and printer base address. |
| 9A | Return after setting timer and printer base address. Going to set the RS-232 base address. |
| 9B | Returned after RS-232 base address. Going to do any initialization before Coprocessor test. |
| 9C | Required initialization before Coprocessor is over. Going to initialize the Coprocessor next. |
| 9D | Coprocessor initialized. Going to do any initialization after Coprocessor test. |
| 9E | Initialization after Coprocessor test is complete. Going to check extended keyboard, keyboard ID and num-lock. |
| A2 | Going to display any soft errors. |
| A3 | Soft error display complete. Going to set keyboard typematic rate. |
| A4 | Keyboard typematic rate set. To program memory wait states. |
| A5 | Going to enable parity/NMI. |
| A7 | NMI and parity enabled. Going to do any initialization required before giving control to optional ROM at E000. |
| A8 | Initialization before E000 ROM control over. E000 ROM to get control next. |
| A9 | Returned from E000 ROM control. Going to do any initialization required after E000 optional ROM control. |
| AA | Initialization after E000 optional ROM control is over. Going to display the system configuration. |
| AB | Put INT13 module runtime image to shadow. |
| AC | Generate MP for multiprocessor support (if present). |
| AD | Put CGA INT10 module (if present) in Shadow. |

continued

Table 73. Runtime Code Uncompressed in F000 Shadow RAM (continued)

| Code | Description of POST Operation |
|------|--|
| AE | Uncompress SMBIOS module and init SMBIOS code and form the runtime SMBIOS image in shadow. |
| B1 | Going to copy any code to specific area. |
| 00 | Copying of code to specific area done. Going to give control to INT-19 boot loader. |

5.3 Bus Initialization Checkpoints

The system BIOS gives control to the different buses at several checkpoints to do various tasks. Table 74 describes the bus initialization checkpoints.

Table 74. Bus Initialization Checkpoints

| Checkpoint | Description |
|------------|--|
| 2A | Different buses init (system, static, and output devices) to start if present. |
| 38 | Different buses init (input, IPL, and general devices) to start if present. |
| 39 | Display different buses initialization error messages. |
| 95 | Init of different buses optional ROMs from C800 to start. |

While control is inside the different bus routines, additional checkpoints are output to port 80h as WORD to identify the routines under execution. In these WORD checkpoints, the low byte of the checkpoint is the system BIOS checkpoint from which the control is passed to the different bus routines. The high byte of the checkpoint is the indication of which routine is being executed in the different buses. Table 75 describes the upper nibble of the high byte and indicates the function that is being executed.

Table 75. Upper Nibble High Byte Functions

| Value | Description |
|-------|---|
| 0 | func#0, disable all devices on the bus concerned. |
| 1 | func#1, static devices init on the bus concerned. |
| 2 | func#2, output device init on the bus concerned. |
| 3 | func#3, input device init on the bus concerned. |
| 4 | func#4, IPL device init on the bus concerned. |
| 5 | func#5, general device init on the bus concerned. |
| 6 | func#6, error reporting for the bus concerned. |
| 7 | func#7, add-on ROM init for all buses. |

Table 76 describes the lower nibble of the high byte and indicates the bus on which the routines are being executed.

Table 76. Lower Nibble High Byte Functions

| Value | Description |
|-------|---|
| 0 | Generic DIM (Device Initialization Manager) |
| 1 | On-board System devices |
| 2 | ISA devices |
| 3 | EISA devices |
| 4 | ISA PnP devices |
| 5 | PCI devices |

5.4 Speaker

A 47 Ω inductive speaker provides audible error code (beep code) information during POST.

| For information about | Refer to |
|---|----------------------|
| The location of the onboard speaker on the Desktop Board D845GVSR | Figure 1, on page 14 |

5.5 BIOS Beep Codes

Whenever a recoverable error occurs during POST, the BIOS displays an error message describing the problem (see Table 77). The BIOS also issues a beep code (one long tone followed by two short tones) during POST if the video configuration fails (a faulty video card or no card installed) or if an external ROM module does not properly checksum to zero.

An external ROM module (for example, a video BIOS) can also issue audible errors, usually consisting of one long tone followed by a series of short tones. For more information on the beep codes issued, check the documentation for that external device.

There are several POST routines that issue a POST terminal error and shut down the system if they fail. Before shutting down the system, the terminal-error handler issues a beep code signifying the test point error, writes the error to I/O port 80h, attempts to initialize the video and writes the error in the upper left corner of the screen (using both monochrome and color adapters).

If POST completes normally, the BIOS issues one short beep before passing control to the operating system.

Table 77. Beep Codes

| Beep | Description |
|-------------|---|
| 1 | Refresh failure |
| 2 | Parity cannot be reset |
| 3 | First 64 KB memory failure |
| 4 | Timer not operational |
| 5 | Not used |
| 6 | 8042 GateA20 cannot be toggled |
| 7 | Exception interrupt error |
| 8 | Display memory R/W error |
| 9 | Not used |
| 10 | CMOS Shutdown register test error |
| 11 | Invalid BIOS (e.g. POST module not found, etc.) |

